

# ***Aspire 9500***

## ***Service Guide***

Service guide files and updates are available on the ACER/CSD web; for more information, please refer to <http://csd.acer.com.tw>

PRINTED IN TAIWAN

---

## ***Revision History***

Please refer to the table below for the updates made on Aspire 9500 service guide.

<b>Date</b>	<b>Chapter</b>	<b>Updates</b>

---

## ***Copyright***

Copyright © 2005 by Acer Incorporated. All rights reserved. No part of this publication may be reproduced, transmitted, transcribed, stored in a retrieval system, or translated into any language or computer language, in any form or by any means, electronic, mechanical, magnetic, optical, chemical, manual or otherwise, without the prior written permission of Acer Incorporated.

## ***Disclaimer***

The information in this guide is subject to change without notice.

Acer Incorporated makes no representations or warranties, either expressed or implied, with respect to the contents hereof and specifically disclaims any warranties of merchantability or fitness for any particular purpose. Any Acer Incorporated software described in this manual is sold or licensed "as is". Should the programs prove defective following their purchase, the buyer (and not Acer Incorporated, its distributor, or its dealer) assumes the entire cost of all necessary servicing, repair, and any incidental or consequential damages resulting from any defect in the software.

Acer is a registered trademark of Acer Corporation.

Intel is a registered trademark of Intel Corporation.

Pentium and Pentium II/III are trademarks of Intel Corporation.

Other brand and product names are trademarks and/or registered trademarks of their respective holders.

---

## ***Conventions***

The following conventions are used in this manual:

<b>SCREEN MESSAGES</b>	Denotes actual messages that appear on screen.
<b>NOTE</b>	Gives bits and pieces of additional information related to the current topic.
<b>WARNING</b>	Alerts you to any damage that might result from doing or not doing specific actions.
<b>CAUTION</b>	Gives precautionary measures to avoid possible hardware or software problems.
<b>IMPORTANT</b>	Reminds you to do specific actions relevant to the accomplishment of procedures.

---

## ***Preface***

Before using this information and the product it supports, please read the following general information.

1. This Service Guide provides you with all technical information relating to the BASIC CONFIGURATION decided for Acer's "global" product offering. To better fit local market requirements and enhance product competitiveness, your regional office MAY have decided to extend the functionality of a machine (e.g. add-on card, modem, or extra memory capability). These LOCALIZED FEATURES will NOT be covered in this generic service guide. In such cases, please contact your regional offices or the responsible personnel/channel to provide you with further technical details.
2. Please note WHEN ORDERING FRU PARTS, that you should check the most up-to-date information available on your regional web or channel. If, for whatever reason, a part number change is made, it will not be noted in the printed Service Guide. For ACER-AUTHORIZED SERVICE PROVIDERS, your Acer office may have a DIFFERENT part number code to those given in the FRU list of this printed Service Guide. You MUST use the list provided by your regional Acer office to order FRU parts for repair and service of customer machines.

<b>Chapter 1</b>	<b>System Specifications</b>	<b>1</b>
	Features .....	1
	MainBoard Placement .....	6
	System Block Diagram .....	9
	Outlook View .....	10
	Indicators .....	16
	Keyboard .....	17
	Touchpad .....	21
	Launch Keys .....	23
	Hardware Specifications and Configurations .....	24
	Jumper Board .....	36
<b>Chapter 2</b>	<b>System Utilities</b>	<b>40</b>
	BIOS Setup Utility .....	40
	System Controls .....	41
	Buttons .....	42
	Information .....	44
	Main .....	46
	Advanced .....	48
	Security .....	51
	Boot .....	52
	Exit .....	53
<b>Chapter 3</b>	<b>Machine Disassembly and Replacement</b>	<b>55</b>
	General Information .....	56
	Aspire 9500 Disassembly Procedure .....	57
	Disassemble the Battery and HDD .....	57
	Disassemble the TV Tuner and Wireless .....	57
	Disassemble the CPU Heatsink .....	58
	Disassemble the RAM and ODD .....	58
	Disassemble the Power Board, Bluetooth and Keyboard .....	59
	Disassemble the Cables, Antenna and LCD Module .....	60
	Disassemble Case, Touchpad and CD-Player .....	61
	Disassemble the Mainboard .....	62
	Disassemble the VGA and Modem board .....	63
	Disassemble the CPU .....	63
	Disassemble the LCD Module .....	64
<b>Chapter 4</b>	<b>Troubleshooting</b>	<b>65</b>
	System Check Procedures .....	66
	PhoenixBIOS POST Tasks and Beep Codes .....	71
	Repair Flowchar. ....	77
<b>Chapter 5</b>	<b>FRU (Field Replaceable Unit) List</b>	<b>102</b>
	Exploded Diagram .....	103
	Aspire 9500 Parts .....	112

# System Specifications

---

## Features

This computer was designed with the user in mind. Here are just a few of its many features:

## Performance

- CPU : Intel® Dothan® with  $\mu$ FCPGA Package
- Intel® Pentium® M Processor 725a**
  - 2MB L2 cache
  - 1.60GHz speed
  - support 400MHz FSB
- Intel® Pentium® M Processor 730/740/750/760/770**
  - 2MB L2 cache
  - 1.60/1.73/1.86/2.13 GHz speed
  - support 533MHz FSB or higher
- Intel® Celeron® M Processor 370**
  - 1M L2 cache
  - 1.5 GHz speed
  - support 400 MHz FSB or higher
- 915 GM (for UMA) / 915 PM ( for discrete VGA ) + ICH6M with PCI-Express technology
- Intel® PRO/Wireless 2200BG network connection (dual-model 802.11 b/g or 802.11 a/b/g)
- Support Wi-Fi CERTIFIED™ solution

## Memory

- DDR II SDRAM memory interface design
- 0MB DDR II RAM on board
- Two DDR II SODIMM slots (dual channel)
- 256MB or 512MB of DDR II 533 memory
- Maximum memory up to 2GB with two 1GB SODIMM slots

## Display

- 17" Wide WSXGA color TFT LCD with 1680 x 1050 pixel resolution, 16.7 million colours
- 17" Wide WXGA color TFT LCD with 1440 x 900 pixel resolution, high-brightness (Dual Lamp)
- 17" Wide WXGA color TFT LCD with 1440 x 900 pixel resolution, Single Lamp
- 16 :10 aspect ratio
- Support simultaneous multi-window viewing via Acer GridVista
- TV-tuner, Analog w/H/W Mpeg or Digital+Analog w/H/W Mpeg or Digital +Analog w/S/W Mpeg (MFG optional)

---

## Graphics

- ATI MOBILITY™ RADEON™ X700(M26P) with 128/256 MB of external DDR video RAM supporting Microsoft® DirectX® 9.0
- ATI POWERPLAY™ 5.0 support
- DualView™ support
- PCI Express™ X16 graphic card support
- Intel® 915GM integrated 3D graphics featuring Intel® Graphics Media Accelerator 900 and up to 128MB of VRAM, supporting Microsoft® DirectX® 9.0
- Dual independent display support
- External resolution/refresh rate
  - 2040x1536: 75/60 Hz
  - 1600x1200: 120/100/85/75/60/ Hz
  - 1280x1024: 160/120/100/85/75/60 Hz
  - 1024x768: 200/160/120/100/85/75/60 Hz
  - 800x600: 200/160/120/100/85/75/60 Hz
- MPEG-2 DVD hardware -assisted capability
- S-video /TV-out (NTSC/PAL) support
- DVI-D (true digital video interface) support
- Aspire CinemaVision™2 video technology (Aspire Arcade)
- Aspire ClearVision™2 video optimisation technology (Aspire Arcade)
- VGA chip : ATI M26P with 128/256MB VRAM

	Discrete VGA	UMA VGA
Media Console	YES	NO
DVI Interface	YES	NO

## Audio

- High Definition Audio (Azalia) support
- Realtek ALC260D
- Built-in two 1.5W speakers
- 2.1 channel speakers with 2W built-in subwoofer
- S/PDIF (Sony/Philips Digital Interface) support for digital speakers
- MS-Sound Compatible
- Built-in microphone
- Dolby digital live is required for Windows XP
- S/W VoIP support



## Storage

- 60/80/100 GB ATA/100 hard disk drive
- 9.5mm height, 2.5" HDD
- PCI Bus Master Enhanced IDE
- Support Ultra DMA100, S.M.A.R.T
- 4200/5400RPM
- PATA/SATA co-layout (one HDD only)
- PATA mode only (HDD: Master, ODD: Slave)
- Mix mode (HDD: SATA-0, ODD: PATA Master)
- 5-in1 card reader, supporting MultiMedia Card (**MMC**), Secure Digital (**SD**), Memory Stick® (**MS**), Memory Stick PRO™ (**MS-Pro**), and xD-Picture Card™

## ODD

- Slot-in type
- 12.7mm DVD-Combo, DVD Dual, and DVD Super Multi

Mode	Performance
DVD-Dual Double Layer Drive	
Read	24X CD-ROM 24X CD-R 24X CD-RW 8X DVD-ROM 8X DVD-R 8X DVD+RW 8X DVD+R 6X LD DVD+R 8X DVD-RW
Write	24X CD-R 24X CD-RW 8X DVD+R 8X DVD-R 4X DVD+RW 2.4X DL DVD+R 4X DVD-RW
DVD/CD-RW Combo Drive	
Read	24X CD-ROM 24X CD-R 24X CD-RW 8X DVD-ROM 8X DVD-R 4X DVD-RW 8X DVD+R 4X DVD+RW
Write	24X CD-R 24X CD-RW

---

## ***PCMCIA***

- PC Card & Carbus card supported with one type II
- no ZV(Zoomed Video) support

## ***Express Card***

- One PCI-Express card (Left side)

## ***Communication***

- 56Kbps V.90/V.92 HD Audio modem card (MDC)
- Gigabit Ethernet LAN on board
- WLAN 802.11b/g and 802.11 a/b/g with mini-PCI interface
- Built-in 2 Antennas
- Bluetooth v2.0 module (Broadcom) with mini-USB interface

## ***I/O Ports***

- Color-coded connectors
- 5 USB 2.0 ports
- 1 Ethernet (RJ-45) port
- 1 Modem (RJ-11) port
- 1 External VGA port
- 1 Infrared (FIR)
- 1 CIR
- 1 90W DC-in jack for AC adaptor
- 1 Microphone-in
- 1 Line-in Jack
- 1 S/PDIF / Headphone/ Speaker-out/ Line-out jack
- 1 S-video port (TV-out)
- 1 DVI-D output port (UMA and Discrete VGA)
- 1 1394(4 pin) port
- 5-in-1 Card Reader (MS, MS Pro, SD, MMC, xD)
- 1 AV-in (7 pin) port (MFG option)
- 1 RF input for digital TV and analog TV (MFG option)
- Small (PCMCIA size) remote control
- Kensington Lock
- Parallel port

## ***Battery***

- 8 cells of Li-ion battery pack (4300mAh)(share with TM4050)
- Smart Battery Compliant
- ACPI 2.2 CPU power management standard supporting Standby and Hibernation power-saving modes

---

## ***System Status Indicators***

<b>LED</b>	<b>Status</b>
Orange	E-mail button Cap Lock Num Lock Media Activity (HDD/ODD)
Green, Orange	System Power
Green, Orange	Battery Charging
Orange	Wireless on/off
Blue	Bluetooth on/off

# Mainboard Placement

## Top View

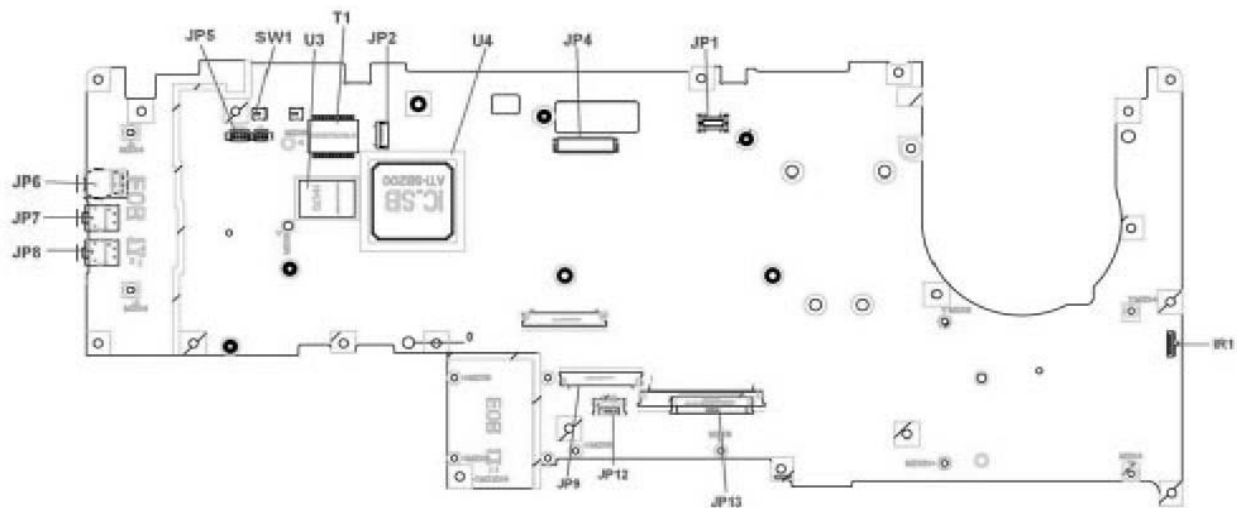

## Rear View

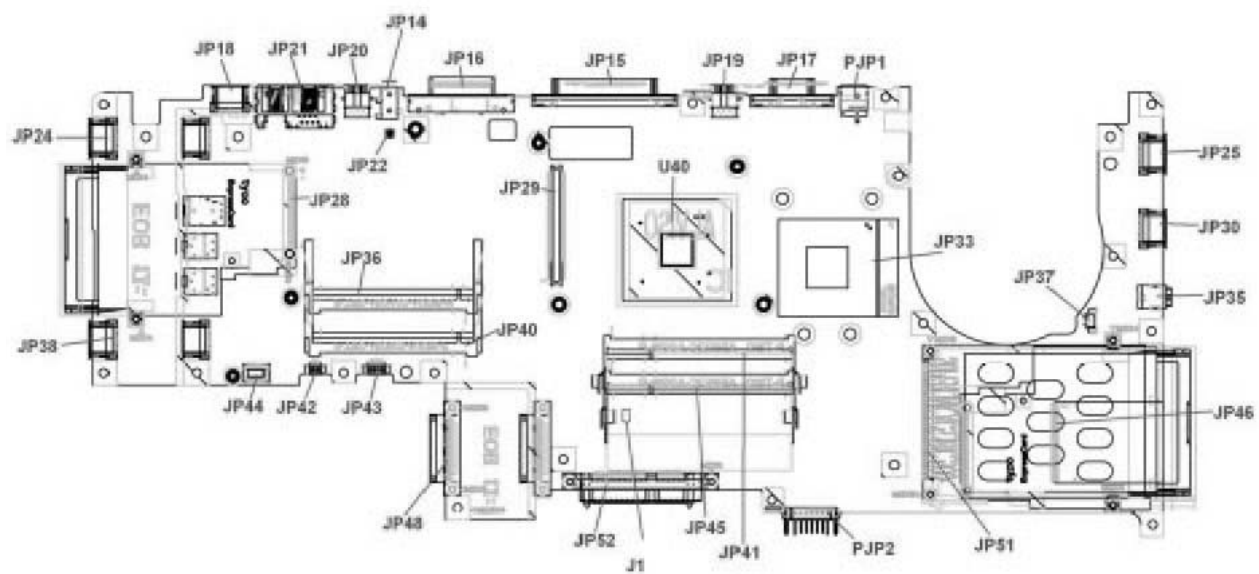

ITEM	DESCRIPTION	ITEM	DESCRIPTION
JP1	To Power/B Connector	JP33	CPU Socket
JP2	Bluetooth Connector	JP35	IEEE1394 Connector
JP4	LCD Connector	JP36	MINIPCI Connector (WLAN)
JP5	Internal MIC Connector	JP37	FAN Connector
JP6	Headphone/SPDIF Jack	JP38	USB Connector
JP7	Line-In Jack	JP40	MINIPCI Connector (TV-Tuner)
JP8	MIC-In Jack	JP41	DDRII SO-DIMM Socket
JP9	Internal K/B Connector	JP42	Internal Subwoofer Connector
JP12	T/P Board Connector	JP43	Internal Speaker Connector
JP13	To LED/B Connector	JP44	MDC Connector
JP14	RF-In Connector	JP45	DDRII SO-DIMM Socket
JP15	Parallel Port Connector	JP46	5 IN 1 Socket
JP16	DVI Connector	JP48	ODD Connector
JP17	CRT Connector	JP51	PCMCIA Socket
JP18	USB Connector	JP52	HDD Connector (P-ATA)
JP19	TV-Out Connector	PJP1	DC-IN Jack
JP20	AV-In Connector	PJP2	Battery Connector
JP21	RJ11/RJ45 Connector	SW1	Lid Switch
JP22	RF to TV-Tuner Connector	U3	LAN Chip
JP24	USB Connector	U4	South Bridge Chipset
JP25	USB Connector	U40	North Bridge Chipset
JP28	Express Card Socket	T1	LAN Transformer
JP29	VGA/B Connector	IR1	FIR Module
JP30	USB Connector	J1	Clear CMOS Jumper

# Block Diagram

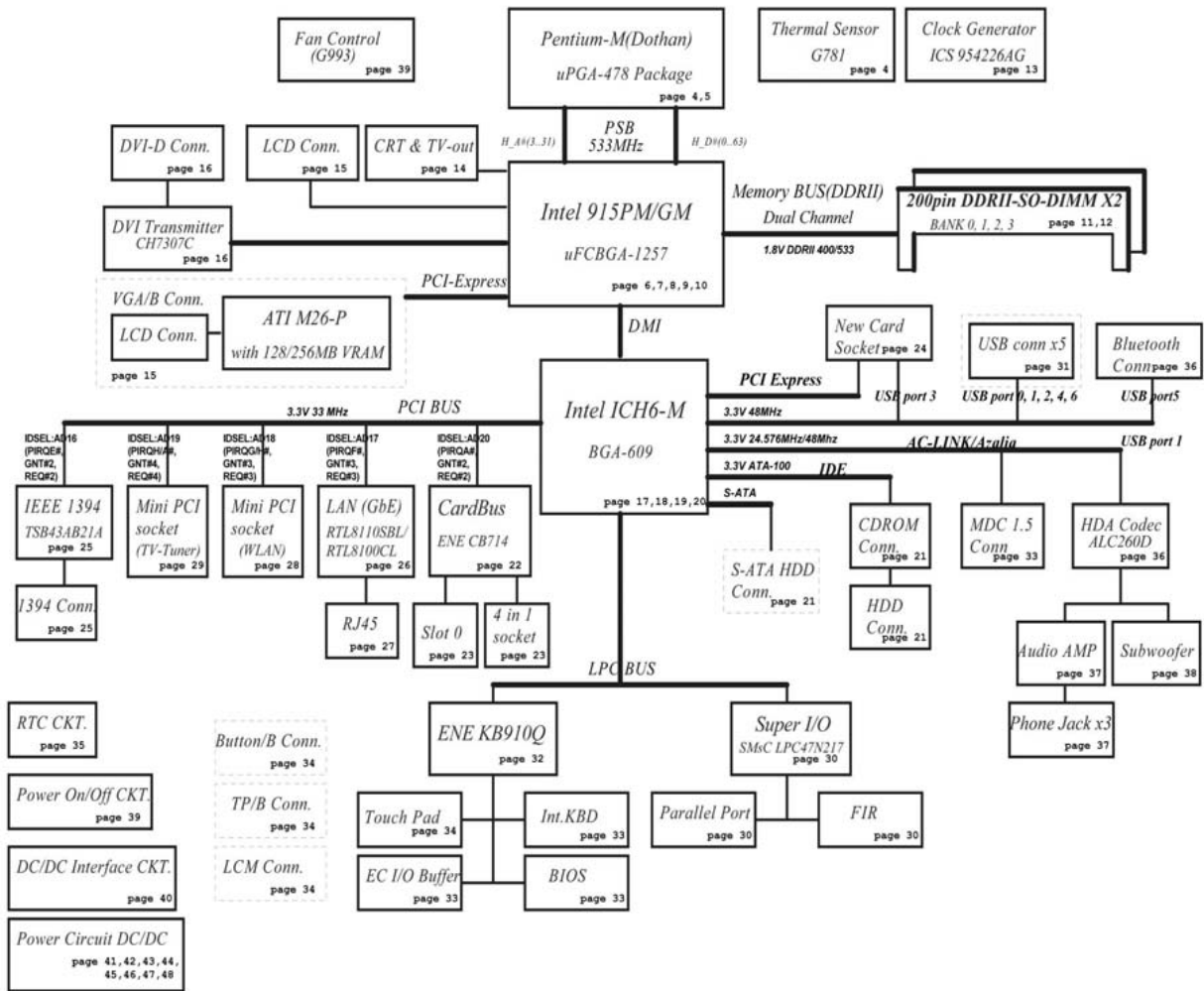

# Outlook View

A general introduction of ports allow you to connect peripheral devices, as you would with a desktop PC.

## Front View

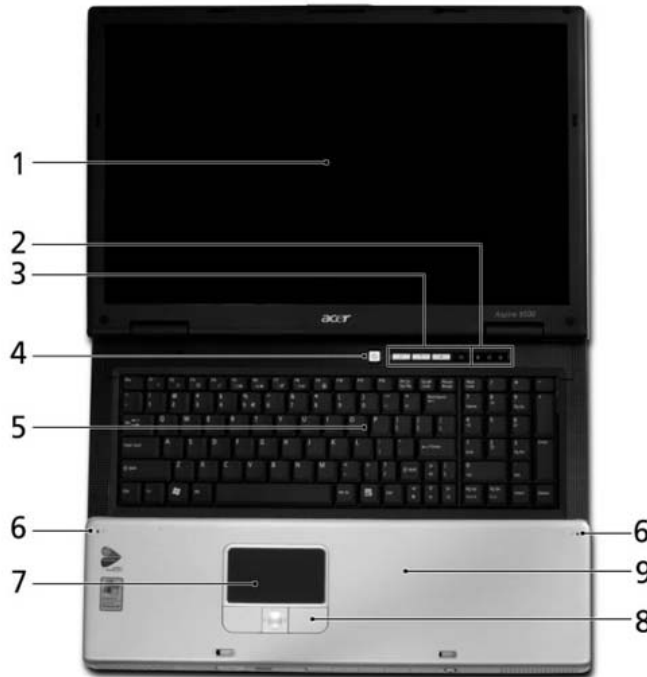

#	Item	Description
1	Display screen	Also called Liquid-Crystal Display (LCD), displays computer output.
2	Status indicators	Light-Emitting Diodes (LEDs) that light up to show the status of the computer's functions and components.
3	Easy-launch buttons	Buttons for launching frequently used programs.
4	Power button	Turns the computer on and off.
5	Keyboard	For entering data into your computer.
6	Microphones	Internal microphones for stereo sound recording.
7	Touchpad	Touch-sensitive pointing device which functions like a computer mouse.
8	Click buttons (left, center and right)	The left and right buttons function like the left and right mouse buttons; the center button serves as a 4-way scroll button.
9	Palmrest	Comfortable support area for your hands when you use the computer.

## Closed Front Panel

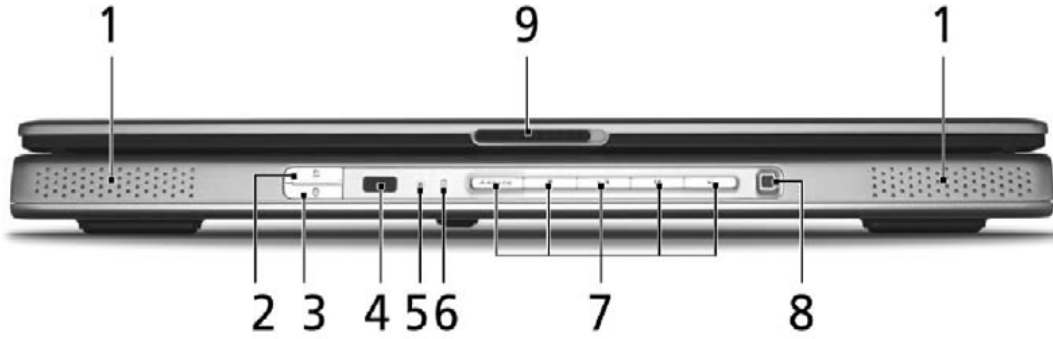



#	Item	Description
1	Speakers	Left and right speakers deliver stereo audio output.
2	Wireless communication button/indicator	Press to enable/disable the wireless function. Lights to indicate the status of wireless LAN communication.
3	Bluetooth communication button/indicator	Press to enable/disable Bluetooth function. Lights to indicate the status of Bluetooth communications.
4	CIR receiver	Receives signals from a remote control.
5	Power indicator	Indicates the computer's power status.
6	Battery indicator	Indicates the computer's battery status.
7	Arcade/media buttons	For use with Acer Arcade and other media playing programs (for selected models).
8	Media control	Five-way multimedia button (for selected models).
9	Latch	Locks and releases the lid.







## Left View



#	Icon	Item	Description
1		USB 2.0 port	USB 2.0 ports
2	Express Card	PCI Express card slot	Accepts one PCI Express card.
3		Headphone/speaker/line-out & S/PDIF jack	Connects to audio line-out devices (e.g., speakers, headphones), S/PDIF compatible
4	N/A	Line-in jack	Accepts audio line-in devices
5		Microphone jack	Accepts input from external microphones.
6	N/A	Slot-load optical drive	Internal optical drive; accepts CDs or DVDs.
7	N/A	Slot-load optical drive eject button	Ejects the optical disk from the drive.
8	N/A	LED indicator	Lights up when the optical drive is active.





## Right View

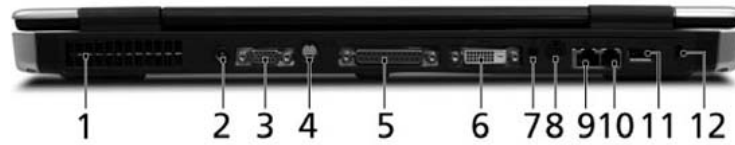

#	Item	Description
1	PC Card slot eject button	Ejects the PC Card from the slot.
2	PC card slot 	Accepts one Type II PC Card.
3	5-in-1 card reader	Accepts Memory Stick, Memory Stick Pro, MultiMediaCard (MMC), Secure Digital (SD), and xD-Picture Card.
4	Infrared port 	Interfaces with infrared devices (e.g. infrared printer, IR-aware computer, etc...)
3	IEEE 1394 Port 	Connects IEEE 1394 devices.
4	Two USB Ports 	Connect to USB 2.0 devices (e.g., USB mouse, USB camera).

## Rear View

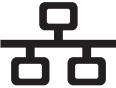

#	Item	Description
1	Ventilation slots	Enable the computer to stay cool, even after prolonged use.
2	DC-in jack 	Connects to an AC adapter.
3	External display (VGA) port 	Connects to a display device (e.g., external monitor, LCD projector).
4	S-video out port 	Connects to a television or display device supporting S-video input.
5	Parallel port	Connects to a printer.
6	DVI-D port	Supports digital video connections. (for selected models)
7	RF jack	For digital and analog TV input (for selected models).
8	Audio/video in port	Supports both audio and video input.(for selected models).
9	Network jack 	Connects the computer to the 10/100/1000 Ethernet network.
10	Modem Jack 	Connects the built-in fax/data modem to a phone line.
11	USB 2.0 port	Connects to USB 2.0 devices (e.g., USB mouse, USB camera).
12	Kensington lock slot	Connects to a Kensington-compatible computer security lock.

## Base View



#	Item	Description
1	Cooling fan	Helps keep the computer cool.
2	Memory compartment	Houses the computer's main memory.
3	Battery lock latch	Locks the battery in place.
4	Battery release latch	Releases the battery for removal.
5	Battery bay	Houses the computer's battery pack.
6	Hard disk bay	Houses the computer's hard disk (secured by a screw).
7	Sub woofer	Emits low frequency sound output.
8	PCI Card bay	Houses the computer's Mini PCI Card.

# Indicators

Your computer provides an array of three indicators located above the keyboard, in addition to four indicators positioned at the front of the palm rest area. These indicators show the status of the computer and its components.



The three indicators located above the keyboard provide the following status information:

Icon	Item	Description
	Caps Lock activity	Lights when Caps Lock is activated.
	Num Lock activity	Lights when Num Lock is activated.
	Media activity	Lights when the hard disk or optical drive is active.
	Bluetooth	Indicates the status of Bluetooth communication.
	Wireless LAN	Indicates the status of wireless LAN communication.
	Power	Lights up when the computer is on. (Lights amber when in stand-by or sleep mode)
	Battery	Lights up when the battery is being charged.

# Keyboard

The keyboard features full-size keys with an embedded keypad, separated cursor keys, two Windows keys, and twelve function keys (hot keys).

## Special keys

### Lock keys



The computer features three lock keys, each with its own status indicator light.









Lock Key	Description
Caps Lock	When Caps Lock is on, all alphabetic characters are typed in uppercase. Toggle on and off by pressing the Caps Lock key on the left side of the keyboard.
Num lock	When Num Lock is on, the embedded numeric keyboard can be used. Toggle on and off by pressing the Fn+  keys simultaneously.
Scroll lock	When Scroll Lock is on, the screen toggles up or down one line at a time when the up and down cursor control keys are pressed.

**NOTE:** Scroll Lock doesn't work in all applications. Toggle on and off by pressing the Fn+F12 keys simultaneously.

## Windows Keys

The keyboard features two keys that perform Windows-specific functions.



Key	Description
Windows logo key 	Pressed alone, this key has the same effect as clicking on the Windows Start button; it launches the Start menu. It can also be used with other keys to provide a variety of functions: <ul style="list-style-type: none"> <li> + Tab (Activates the next Taskbar button)</li> <li> + E (Opens the My Computer window)</li> <li> + F1 (opens Help and Support)</li> <li> + F (opens the Find: All Files dialog box)</li> <li> + M (minimizes all windows)</li> <li> + Windows icon + M (undoes the minimize all windows action)</li> <li> + R (opens the Run dialog box)</li> </ul>
Application key 	This key has the same effect as clicking the right mouse button; it opens the application's context menu.

## Function Keys

Using the Fn key with another key creates a hot key, providing a quick and convenient method for controlling various functions.

To use a hot key, first hold down the Fn key. Next, press the second key in combination. Finally, release both keys.



Your computer provides the following hot keys:

Hot Key	Function	Description
Fn+F1	Hot key help	Displays help on hot keys
Fn+F2	Setup	Access the computer's configuration utility.
Fn+F3	Power management scheme toggle	Switches the power management scheme used by the computer (function available if supported by operating system).
Fn+F4	Sleep	Puts the computer in Sleep mode.
Fn+F5	Display toggle	Switches display output between the display screen, external monitor (if connected) and both the display screen and external monitor.
Fn+F6	Screen blank	Turns the display screen backlight off to save power. Press any key to return.
Fn+F7	Touchpad toggle	Turns the internal touchpad on and off.
Fn+F8	Speaker toggle	Turns the speaker on and off.
Fn+Sub-woofer key	Sub-woofer	Turns the sub woofer on and off
Fn+	Volume up	Increases the speaker volume.
Fn+	Volume down	Decreases the speaker volume.
Fn+	Brightness up	Increases the screen brightness.
Fn+	Brightness down	Decreases the screen brightness.

**NOTE:** When activating hotkeys, press and hold the **Fn** key before pressing the other key in the hotkey combination.



---

## ***Euro key***

Your computer supports the new Euro currency character. First, hold down the Alt Gr key, and then press the Euro key.



# Touchpad

The build-in touchpad is a PS/2 compatible pointing device that senses movement on its surface.

The cursor responds to your finger movements on the touchpad. In addition, the two click buttons provide the same functionality as a computer mouse, while the scroll key enables easy up and down scrolling in documents and web pages.

The touchpad is located in the middle of the palm rest area, providing maximum comfort and efficiency.



## Touchpad Basics

Use the touchpad as follows:

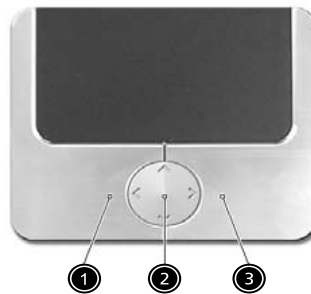

- Slide your finger over the surface of the touchpad to control the movement of the cursor. Tap the touchpad to perform selection and execution functions.
- Press the left (1) and right (3) buttons to perform selection and execution functions, just as you would use the buttons on a computer mouse.
- Use the scroll key (2) to scroll through long documents and web pages. Press the top of the key to scroll up, and the bottom to scroll down; left to scroll left, and right to scroll right.

Function	Left Button	Righ Button	4-Way Scroll Way	Tap
Execute	Click twice quickly			Tap twice (at the same speed as double-clicking the mouse button)
Select	Click once			Tap once

Function	Left Button	Righ Button	4-Way Scroll Way	Tap
Drag	Click and hold. Then slide your finger across the touchpad to drag the cursor over the selection.			Tap twice quickly. On the second tap, slide your finger across the touchpad to drag the cursor over the selection.
Access context menu			Click once	
Scroll			Click and hold the up/down/left/right button	

**NOTE:** Keep your fingers, as well as the surface of the touchpad dry and clean. The touchpad is sensitive to your finger movements: the lighter the touch, the better the response. Tapping hard will not increase the touchpad's responsiveness.

---

## Launch Keys

Located at the top of the keyboard are four buttons, in addition to the power button. These buttons are called launch keys. They are designed as key 1, key 2, key 3 and key 4, from right to left. By default, key 1 is used to launch the email application and key 2 is used to launch the Internet browser. Key 3 and key 4 start the Launch Manager application. The first four launch keys can be set by the user. To set the launch keys, run the Acer Launch Manager.



#	Description
e	Launches your email application.
P	User-programmable
Web browser	Internet browser application
Mail	Email application

---

# Hardware Specifications and Configurations

## Processor

Item	Specification
CPU type	Intel Pentium M 1.6G ~ 2.13G
CPU package	478pin
CPU core voltage	Depend on VID
CPU I/O voltage	1.05V

## BIOS

Item	Specification
BIOS vendor	Insyde
BIOS Version	Insyde
BIOS ROM type	Flash ROM
BIOS ROM size	512KB
BIOS package	32 lead of TSSOP
BIOS password control	Set by setup manual

## Second Level Cache

Item	Specification
Cache controller	Built-in CPU
Cache size	2MB
1st level cache control	Always enabled
2nd level cache control	Always enabled
Cache scheme control	Always enabled

## System Memory

Item	Specification
Memory controller	Intel 915PM/GM
Memory size	256MB/512MB/1GB
DIMM socket number	2 slots
Supports memory size per slot	1024MB
Supports maximum memory size	2GB (by two 1024MB SO-DIMM module)
Supports DIMM type	DDR II DRAM
Supports DIMM Speed	400/533MHz
Supports DIMM voltage	1.8V
Supports DIMM package	200-pin SO-DIMM
Memory module combinations	You can install memory modules in any combinations as long as they match the above specifications.

### Memory Combinations

Slot 1	Slot 2	Total Memory
256/512MB/1024MB	0 MB	256MB/512MB/1024MB
256/512MB/1024MB	256MB	512MB/768MB/1280MB
256/512MB/1024MB	512MB	768MB/1024MB/1536MB
256/512MB/1024MB	1024MB	1280MB/1536MB/2048MB

**NOTE:** Above table lists some system memory configurations. You may combine DIMMs with various capacities to form other combinations.

### System Major Chip

Item	Controller
System core logic	Intel 915GM/PM + ICH6M
Super I/O controller	SMSC 47N217, LPC interface
Audio controller	Realtek ALC260D Codec
Video controller	ATI M26P
Hard disk drive controller	ICH6M
Keyboard controller	ENE KB910Q
RTC	ICH6M
LAN controller	RTL8110SBL
IEEE 1394 controller	TPA43AB21A

### LAN Interface

Item	Specification
Supports LAN protocol	1Gbps
LAN connector type	RJ45
LAN connector location	Rear Side

### Modem / Bluetooth Interface

Item	Specification
Data modem data baud rate (bps)	56K
Supports modem/bluetooth protocol	V.90/V.92 HD Audio modem card (MDC)
Modem connector type	RJ11
Modem connector location	Rear Side

### Hard Disk Drive Interface

Item	Specification			
Vendor & Model Name	<b>HITACHI Moraga A</b> IC25N060ATMR04-0 <b>SEAGATE N2</b> ST960821A <b>Toshiba Pluto</b> MK6025GAS	<b>HITACHI Moraga A</b> IC25N060ATMR04-0 <b>SEAGATE N2</b> ST9808210A <b>Toshiba Pluto</b> MK8025GAS	<b>SEAGATE N2</b> ST9100822A <b>Toshiba Pluto</b> MK1031GAS	<b>HITACHI Moraga+B</b> HTS541010G9AT00 <b>SEAGATE</b> ST9100823A <b>Toshiba Aries-B</b> MK1032GAX
Capacity (MB)	60000	80000	100000	100000

Item	Specification	
Vendor & model name	Panasonic Dual Slot-in UJ-845	
Performance Specification	CD-R/RW	DVD-ROM/RW
Soft Read Error	Less than 10 <sup>-9</sup>	
Hard Read Error	Less than 10 <sup>-12</sup>	
Data Buffer Capacity	2 MBytes	
Interface	IDE (ATAPI Compliant)	
Speed	Reading : 24X Speed CD-ROM Writing : 16X Speed CD-RW 24X Speed CD-R	Reading : 8X Speed DVD-ROM Writing : 5X Speed DVD-RAM 8X Speed DVD-R 4X Speed DVD-RW
Applicable disc format	DVD: DVD-ROM (DVD-5, DVD-9, DVD-10), DVD-R (3.95G/4.7G), DVD-RAM (2.6G/4.7G), DVD-RW CD: CD-Audio, CD-ROM(mode 1 and mode 2), CD-ROM XA ( mode2, form 1 and form 2), CD-RW Photo CD Video CD Enhanced Music CD CD-TEXT	
<b>Power Requirement</b>		
Input Voltage	+5 V +/- 5 %	

Item	Specification	
Vendor & model name	Panasonic Tray UJDA-770	
Performance Specification	CD-R/RW	DVD-ROM/RW
Soft Read Error	Less than 10 <sup>-9</sup>	
Hard Read Error	Less than 10 <sup>-12</sup>	
Data Buffer Capacity	2 MBytes	
Interface	IDE (ATAPI Compliant)	
Speed	Reading : Max 24X CAV CD-R Writing : Max24X Zone CLV CD-R 4X CLV CD-RW	Reading : MAX 8X CAV (MAX 10800 kB/s) DVD-ROM
Applicable disc format	DVD: DVD-ROM DVD-R, DVD-RW(Ver. 1.1) DVD-RAM(2.6GB, 4.7GB) DVD+R, DVD+RW CD: CD-DA,CD-ROM,CD-ROM XA CD-R,CD-RW PhotoCD(multiSession),Video CD CD-Extra(CD+),CD-text	
<b>Power Requirement</b>		
Input Voltage	+5 V +/- 5 %	

Item	Specification	
Vendor & model name	Pioneer DVR-K05RV	
Performance Specification	CD-R/RW	DVD-ROM/RW
Soft Read Error	Less than 10 <sup>-9</sup>	
Hard Read Error	Less than 10 <sup>-12</sup>	
Data Buffer Capacity	2 MBytes	
Interface	IDE (ATAPI Compliant)	
Speed	Reading : 24X CAV at CD-ROM and CD-R / RW Writing : 24X CAV at CD-R 24X Zone CLV at CD-RW	Reading : 8XCAV at DVD-ROM (Single Layer) & DVD-R / RW or+R/RW 6X CAV at DVD-ROM (Dual Layer) & DVD-R-DLor +R-DL 2X Zone CLV at DVD-RAM Writing : 8X CAV at DVD-R or +R 8X Zone CLV at DVD+RW 6X Zone CLV at DVD-RW 4X Zone CLV at DVD-R-DL (Dual Layer)or +R-DL (Double Layer)



Item	Specification
Applicable disc format	KODAK Photo CD Single and Multi-session CD Extra (CD PLUS) Video CD CD text data (Read / Write) CD-R discs (Read / Write) CD-RW discs (Read / Write) DVD-ROM DVD-R Ver.2.00 for General (Read / Write) DVD-R-DL (Read/Write) DVD-RW Ver.1.0 & 1.1 & 1.2 (Read / Write) +R Ver.1.0 & 1.11 & 1.2 (Read/Write) +R -DL Ver1.0 (Read / Write) +RW Ver.1.1 & 1.2 (Read/Write) DVD-RAM (Ver.2.0 & 2.1) (Read only)
<b>Power Requirement</b>	
Input Voltage	+5 V +/- 5 %

### **Audio**

Item	Specification
Audio Controller	Realtek ALC 260D
Audio onboard or optional	Built-in
Mono or Stereo	Stereo
Resolution	20 bit stereo Digital to analog converter 18 bit stereo Analog to Ditial converter
Compatibility	Microsoft PC99/2100, AC97 2.3 & WHQL/WLP2.0
Mixed sound source	CD
Sampling rate	96 KHz
Internal microphone	No
Internal speaker / Quantity	Yes / 2

### Hard Disk Drive Interface

Item	Specification			
Bytes per sector	512	512	512	512
Data heads	3/3/4	4/4/4	4/4/4	4/4/4
<b>Drive Format</b>				
Disks	2/2/2	2/2/2	2/2/2	2/2/2
Spindle speed (RPM)	4200 RPM	4200 RPM	4200 RPM	4200 RPM
<b>Performance Specifications</b>				
Buffer size	8192KB	8192KB	8192KB	8192KB/8192KB/16384KB
Interface	ATA-6	ATA-6	ATA-6	ATA-6
Max. media transfer rate (disk-buffer, Mbytes/s)	350Mb/s	350Mb/s	350Mb/s	493Mb/s
Data transfer rate (host~buffer, Mbytes/s)	100 MB/Sec. Ultra DMA mode-5	100 MB/Sec. Ultra DMA mode-5	100 MB/Sec. Ultra DMA mode-5	100 MB/Sec. Ultra DMA mode-5
<b>DC Power Requirements</b>				
Voltage tolerance	5V(DC) +/- 5%	5V(DC) +/- 5%	5V(DC) +/- 5%	5V(DC) +/- 5%

### Optical Drive Interface

Item	Specification	
Vendor & model name	Panasonic Combo SLOT-IN CW 8124	
Performance Specification	CD-R/RW	DVD-ROM
Soft Read Error	Less than 10 <sup>-9</sup>	
Hard Read Error	Less than 10 <sup>-12</sup>	
Data Buffer Capacity	2 MBytes	
Interface	IDE (ATAPI Compliant)	
Speed	Reading : 24x speed CD-ROM Writing : 24x speed CD-R 24x speed CD-RW writing	Reading : 8x speed DVD-ROM DVD MULTI Read Support

### ***Optical Drive Interface***

<b>Item</b>	<b>Specification</b>
Applicable disc format	DVD: DVD-ROM (DVD-5, DVD-9, DVD-10), DVD-R (3.95G/4.7G), DVD-RAM (4.7G), DVD-RW CD: CD-Audio, CD-ROM(mode 1 and mode 2), CD-ROM XA ( mode2, form 1 and form 2), CD-RW Photo CD Video CD Enhanced Music CD CD-TEXT
<b>Power Requirement</b>	
Input Voltage	+5 V +/- 5 %

### ***Video Interface***

<b>Item</b>	<b>Specification</b>
Video vendor	ATI
Video name	M26P
Chip voltage	Core/1.2V, 1.5V
Supports ZV (Zoomed Video) port	No

### ***Video Resolution Mode (for both LCD and CRT)***

<b>Resolution</b>	<b>16 bits (High color)</b>	<b>32 bits (True color)</b>
1440*900 (WXGA)	Yes	Yes
1680*1050(WSXGA+)	Yes	Yes

### ***USB Port***

<b>Item</b>	<b>Specification</b>
USB compliancy level	2.0
OHCI	USB 2.0
Number of USB port	5
Location	Rear side x1 Left side x 2 Right side x2

### ***PCMCIA Port***

<b>Item</b>	<b>Specification</b>
PCMCIA controller	ENE CB714 CardBus
Supports card type	Type II
Number of slots	One type-II
Access location	Left Side
Supports ZV (Zoomed Video) port	No
Supports 32 bit CardBus	Yes

## Keyboard

Item	Specification
Keyboard Controller	ENE KB910Q
Total Number of Keypads	103 keys with 12 function keys
Function Keys	<input type="checkbox"/> Four cursor keys <input type="checkbox"/> Two Windows keys <input type="checkbox"/> Hotkey controls <input type="checkbox"/> Embedded numeric keypad <input type="checkbox"/> International language support
Easy-Launch Buttons	<input type="checkbox"/> Internet <input type="checkbox"/> Email <input type="checkbox"/> Empowering button <input type="checkbox"/> User-programmable button
Two Front-Access LED Buttons	<input type="checkbox"/> WLAN <input type="checkbox"/> Bluetooth
Windows logo key	Yes
Internal & external keyboard work simultaneously	Yes

## Battery

Item	Specification
Vendor & model name	<b>Sony/Sanyo</b>
Battery Type	Li-ion
Pack capacity	60Wh
Cell voltage	3.7V/cell/2000mAh High discharge rate
Number of battery cell	8
<b>Package configuration</b>	
Pin 1 Pin 2	BATT+: Battery+, Battery Positive Terminal
Pin 3	ID : Identify Pin (Note 1)
Pin 4	B/I : Battery-In Pin
Pin 5	TS : Connect to Thermister
Pin 6	SMD : SMBus data interface I/O pin
Pin 7	SMC : SMBus clock interface I/O pin
Pin 8 Pin 9	GND : Battery Negative Terminal

**NOTE:** 1. Li-ion Battery: Connect 1K  $\pm$ 5 % ohm resistor to GND in Battery PCB.

**NOTE:** B/I pin: Battery can be Charged/Discharged only while this pin is connected to GND.

### LCD Inverter Specification

No.	Panel	Model	Type	Frequency (KHz)	Current (mA)	VS at 0° C	Work Voltage	Brightness
1	Samsung	LTN170WP-L02-0	17" WSXGA+	40/60/65	4/6/6.5	1950 Vrms	730 Vrms at 6mA	155/180
2	Samsung	LTN170WX-L05-E	17" WXGA	40/60/65	3/6/6.8	1690 Vrms	730 Vrms at 6mA	175/200
3	LG	LP171WP5-TL03	17" WXGA	40/60/70	3/6/6.5	1500 Vrms	760 Vrms at 6mA	420/500
4	LG	LP171WX2-A4K5	17" WXGA	40/60/70	3/6.5/6.8	1500 Vrms	735 Vrms at 6.5mA	200(typ.)
5	AUO	B170PW01 V.1	17" WXGA	40/50/80	3/6.5/7	1500 Vrms	815 Vrms at 6.5mA	170/200
6	QDI	QD17TL02-02	17" WXGA	50/TBD/60	3/6/6.5	1660 Vrms	724 Vrms at 6.5mA	175/200

### LCD

Item	Specification					
Vendor & model name	Samsung LTN170W P-L02-0	Samsung LTN170W X-L05-E	LG LP171WP 5-TL03	LG LP171WX 2-A4K5	AUO B170PW0 1 V.1	QDI QD17TL0 2-02
<b>Mechanical Specifications</b>						
LCD display area (diagonal, inch)	17"	17"	17"	17"	17"	17"
Display technology	TFT	TFT	TFT	TFT	TFT	TFT
Resolution	WSXGA (1440*900)	WXGA (1440*900)	WXGA (1440*900)	WXGA (1440*900)	WXGA (1440*900)	WXGA (1440*900)
Supports colors	262K	262K	262K	262K	262K	262K
<b>Optical Specification</b>						
Brightness control	keyboard hotkey	keyboard hotkey	keyboard hotkey	keyboard hotkey	keyboard hotkey	keyboard hotkey
Contrast control	No	No	No	No	No	No
Suspend/ Standby control	Yes	Yes	Yes	Yes	Yes	Yes

### AC Adapter

Item	Specification
Vendor & model name	Delta 90W ADP-90SB BBAC Lite-On 90W PA1900-04 AC

## AC Adapter

Item	Specification
Input Requirements	
Maximum input current (A, @100Vac, full load)	1.8A max@3.5A/100Vac and 240 Vac
Nominal frequency (Hz)	47 - 63
Frequency variation range (Hz)	47 - 63
Nominal voltages (Vrms)	90 - 264
Inrush current	The maximum inrush current will be less than 50A and 100A when the adapter is connected to 100Vac(60Hz) and 240Vac(50Hz) respectively.
Efficiency	High efficiency 85% minimum, at 100~240Vac AC input, full load, warm-up condition.
Output Ratings (CV mode)	
DC output voltage	Offers constant voltage 19.0V output source with 150W max output power capacity.
Noise + Ripple	300mvp-pmax (20MHz bandwidth) for resistor load
Output current	0 A (min.) 3.5A (max.)
Output Ratings (CC mode)	
DC output voltage	18.0 ~ 20.0
Constant output	7.74A
Dynamic Output Characteristics	
Start-up time	3 sec. (@115 Vac and 230Vac full load)
Hold up time	5ms min. (@115 Vac input, full load)
Over Voltage Protection (OVP)	25V
Short circuit protection	Output can be shorted without damage, and auto recovery
Electrostatic discharge (ESD)	15kV (at air discharge) 8kV (at contact discharge)
Dielectric Withstand Voltage	
Primary to secondary	4242 Vdc for 1 second-
Leakage current	60uA at 240Vac/60Hz
Regulatory Requirements	1. FCC class B requirements (USA) 2. VDE class B requirements (German) 3. VCCI classII requirements (Japan)

## Power Management

ACPI Mode	Power Management
Mech. Off (G3)	All devices in the system are turned off completely.
Soft Off (G2/S5)	OS initiated shutdown. All devices in the system are turned off completely.
Working (G0/S0)	Individual devices such as the CPU and hard disk may be power managed in this state.

### ***Power Management***

<b>ACPI Mode</b>	<b>Power Management</b>
Sleeping State (S3)	CPU Power Down VGA Power Down PCMCIA Suspend Audio Power Down Hard Disk Power Down Super I/O Power Down
Sleeping State (S4)	Also called Hibernate state. System saves all system states and data onto the disk prior to power off the whole system.

### ***Environmental Requirements***

<b>Item</b>	<b>Specification</b>
Temperature	
Operating	+5 ~ +35°C
Non-operating	-20 ~ +65°C (storage package)
Humidity	
Operating	10% ~ 90% without condensation
Altitude	Operating sea level 0 to 10,000ft
	Storage sea level 0 to 40,000ft

### ***Mechanical Specification***

<b>Item</b>	<b>Specification</b>
Dimensions	15.83" x 11.26" x 1.2" 402(W)mm x 286(D)mm x 35/37(H) mm
Weight	3.6 kg with single lamp LCD module 3.7 kg with dual lamp LCD module

## Mechanical Specification

Item	Specification
I/O Ports	<ul style="list-style-type: none"><li><input type="checkbox"/> Five USB 2.0 ports</li><li><input type="checkbox"/> IEEE 1394 port</li><li><input type="checkbox"/> Ethernet (RJ-45) port</li><li><input type="checkbox"/> Modem (RJ-11) port</li><li><input type="checkbox"/> External display (VGA) port</li><li><input type="checkbox"/> S-video/TV-out (NTSC/PAL) port</li><li><input type="checkbox"/> DVI-D port</li><li><input type="checkbox"/> Parallel port</li><li><input type="checkbox"/> Microphone-in jack</li><li><input type="checkbox"/> Line-in jack</li><li><input type="checkbox"/> Headphones/Speaker/Line-out/SPDIF port</li><li><input type="checkbox"/> Infrared (FIR) port</li><li><input type="checkbox"/> CIR (at the front side)</li><li><input type="checkbox"/> Type II PC Card slot</li><li><input type="checkbox"/> AV-in (7-pin) port (MFG option)</li><li><input type="checkbox"/> RF input for digital TV and analog TV (MFG option)</li><li><input type="checkbox"/> 5-in-1 card reader (MS/MS-Pro/ MMC/ SD/xD-Picture card™)</li><li><input type="checkbox"/> DC-in jack for AC adaptor</li><li><input type="checkbox"/> Express Card</li></ul>
Drive Bays	One
Material	Recycle plastic PC+ABS 94V0
Media Console	<ul style="list-style-type: none"><li><input type="checkbox"/> Arcade button</li><li><input type="checkbox"/> Stop button</li><li><input type="checkbox"/> Play/Pause button</li><li><input type="checkbox"/> Fast Forward</li><li><input type="checkbox"/> Rewind</li><li><input type="checkbox"/> 5-way Switch</li></ul>



## Jumper Board

### VGA Board

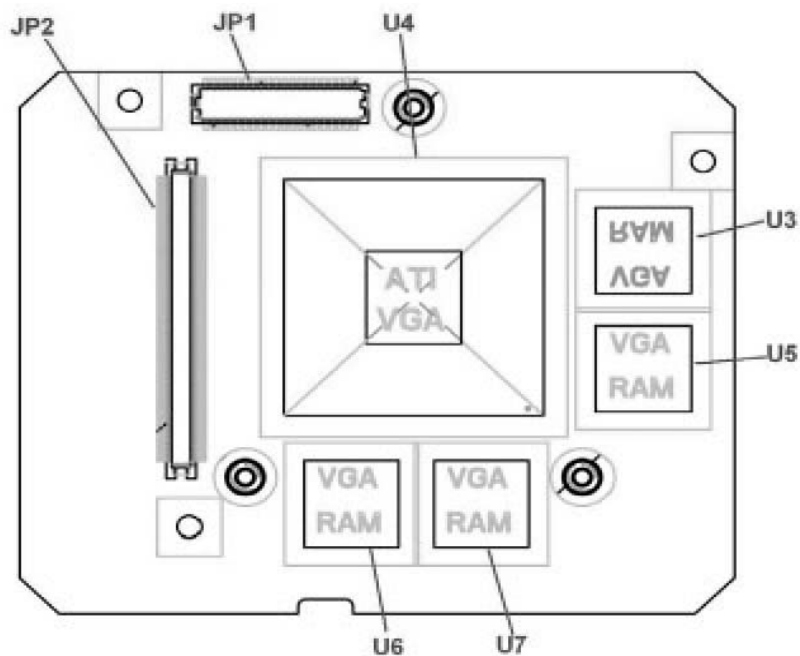

Item	Description
JP1	To LCD Connector
JP2	To M/B Connector
U4	VGA Chip
U3,U5,U6,U7	Graphic Memory

## Power Board

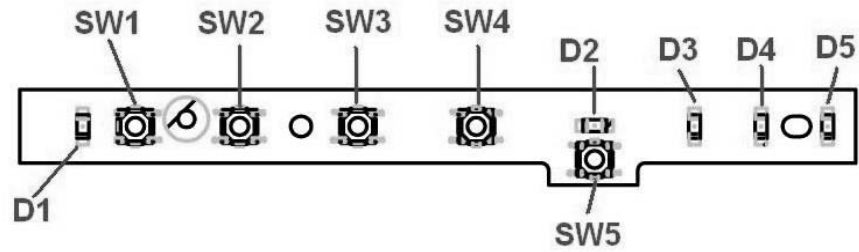

Item	Description	Item	Description
SW1	Power Button	D1	Power LED
SW2	Empowering Button	D2	E-Mail LED
SW3	User Button 1	D3	Media LED
SW4	Internet Button	D4	Caps Lock LED
SW5	E-Mail Button	D5	Num Lock LED

## Touchpad Board

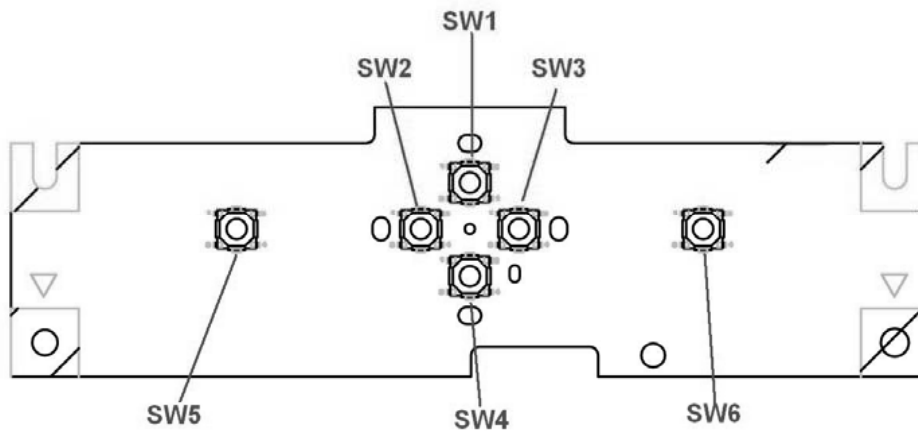

Item	Description	Item	Description
SW1	Scroll-up Button	SW4	Scroll-down Button
SW2	Scroll-left Button	SW5	Left Button
SW3	Scroll-right Button	SW6	Right Button

## LED Board

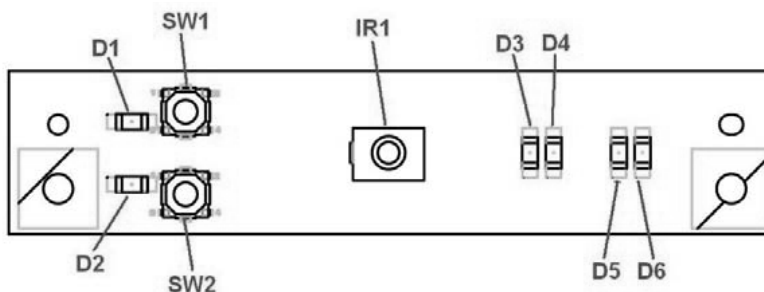

Item	Description	Item	Description
SW1	WLAN ON/OFF Button	D4	Suspend LED
SW2	Bluetooth ON/OFF Button	D5	Battery Discharge LED
D1	WLAN LED	D6	Battery Charge LED
D2	Bluetooth LED	IR1	CIR Module
D3	POWER LED		

## Media Board

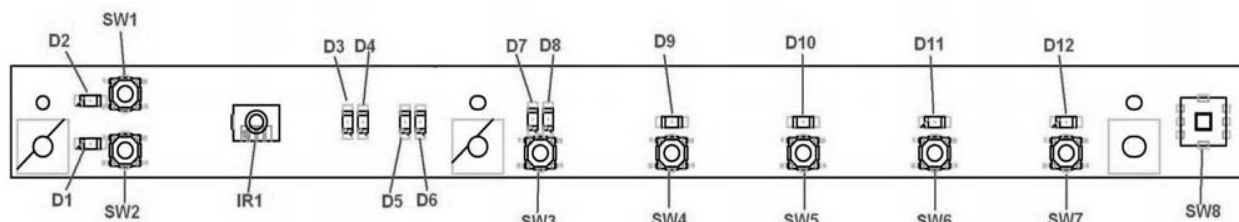

Item	Description	Item	Description
SW1	WLAN ON/OFF Button	D4	Suspend LED
SW2	Bluetooth ON/OFF Button	D5	Battery Discharge LED
SW3	ARCADE Button	D6	Battery Charge LED
SW4	PLAY/PAUSE Button	D7	ARCADE LED
SW5	STOP Button	D8	ARCADE ON LED
SW6	REV Button	D9	LED
SW7	FWD Button	D10	LED
SW8	5-Way Button	D11	LED
D1	Bluetooth LED	D12	LED
D2	WLAN LED	IR1	CIR Module
D3	POWER LED		

## Clear CMOS Jumper

J1 : Clear CMOS JUMPER

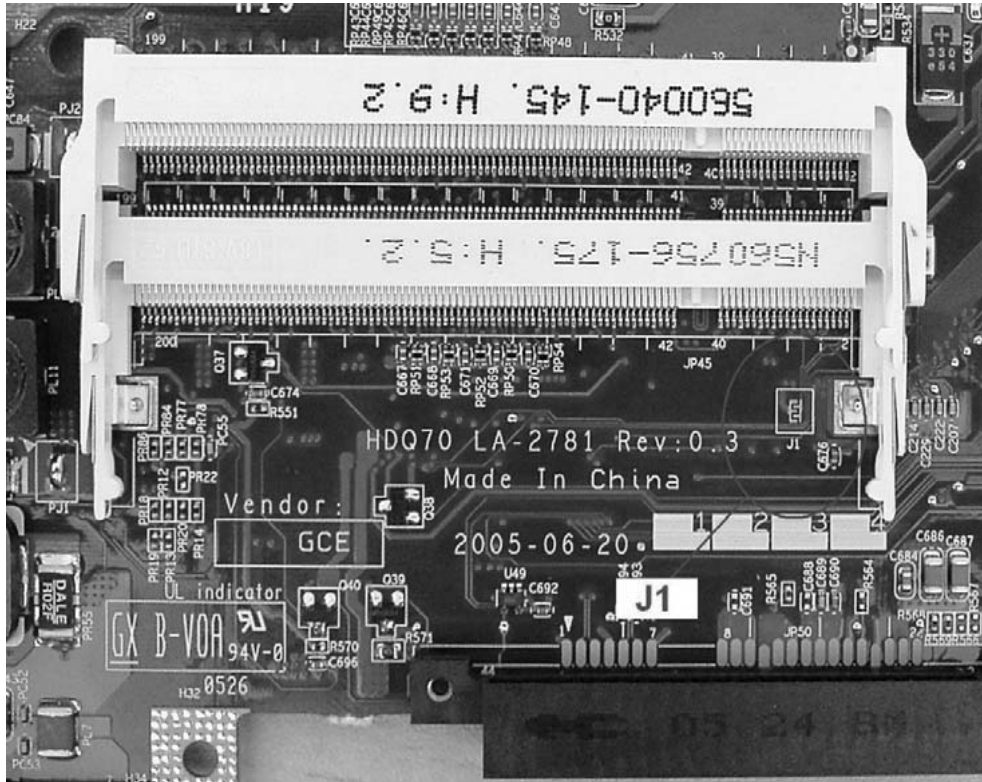

## System Utilities

### BIOS Setup Utility

The BIOS Setup Utility is a hardware configuration program built into your computer's BIOS (Basic Input/Output System).

Your computer is already properly configured and optimized, and you do not need to run this utility. However, if you encounter configuration problems, you may need to run Setup. Please also refer to Chapter 4 Troubleshooting when problem arises.

To activate the BIOS Utility, press **F2** during POST (when "Press <F2> to enter "Setup" message is prompted on the bottom of screen).

The setup screen displays BIOS as follows: Navigating the BIOS Utility

Function	Item
Information	Display the system informations
Main	Allows the user to specify standard IBM PC AT system parameters
Advanced	Provides advanced settings of the system
Security	Provides security settings of the system
Boot	Allows the user to specify the boot options
Exit	Allows the user to save CMOS setting and exit Setup





During setup, all Fn function keys and power saving functions are disabled.

There are five menu options: Main, Advanced, Security, Boot and Exit.

# System Controls

## Hot Keys

All Fn Key will support Sticky key mode.

Hot Key	Function	Description
Fn + F1	Hot key Help Menu	This key will cause a help message to appear on the display device that describes the definition and functionality of the unit hot keys. It is preferred to have the key activate a graphical display.
Fn + F2	Launch Acer eSettings	This key will launch Acer eManager->eSetting
Fn+ F3	Launch Acer ePM	It will launch Acer ePowerManagement.
Fn + F4	SleepButton in ACPI mode	In ACPI mode, the OS provides two buttons for sleep function. One is the Power On button and the other is the Sleep Button. "Fn+F4" is assigned as the Sleep button in ACPI mode. User can set the action of the Sleep Button on the Power Management property.
Fn + F5	Launch Display Mode Menu (DMM)	Follow DMM Specification except in OS other than 32-bit Windows
Fn + F6	Display blank (backlight off)	This key will cause the LCD back light to be turned off. This provides both a quick security feature and some power savings. The LCD back light can also be turned off via an APM timer. The LCD back light will be turned on again when any of the following events occur: <ol style="list-style-type: none"> <li>Any key pressed</li> <li>Pointing device movement</li> </ol> USB device does not need to support.
Fn + F7	Touchpad On/Off	This key will cause the internal touchpad pointing device to be disabled/enabled . This is to prevent accidental system wake-ups from standby. Pressing this key a second time will re-enable the touch pad pointing device. BIOS check Internal AuxDev if not exist then BIOS empty return.
Fn + F8	Speaker On/Off	This key will cause the audio output to the speakers to muted or disabled. Pressing this key a second time will re-enable the audio output to the speakers.
Fn + F9	Launch arcade	Launch the multimedia application that supports DVD player, CD player, picture explorer, TV turner and MP3 player.
Fn + 	Volume up	These keys will cause the volume of the audio chip to be increased or decreased. When the hotkeys are pressed and the volume are changing then system will pop one volume status menu to show the status. This function should be handled by the system Volume utility within the each key makes.
Fn + 	Volume down	
Fn + 	Brightness up	These keys can increase or decrease the brightness of the LCD back light. This function should be handled by the Analog function within the keyboard controller (KBC). Brightness will step up/down one unit as each time these keys are pressed.
Fn + 	Brightness down	
Alt + F10	Enter D2D recovery during POST Launch Acer eRecovery in OS	Enter D2D recovery during POST Launch Acer eRecovery in OS

Euro, and USD dollar key: Under different language OS, user is able to input Euro dollar sign, and USD dollar sign when word processing.

---

## Buttons

### Application Launch Buttons

Launch Keys	Description
Launch Button P	<Launch manager>
Launch Button e	<Launch eManager>
<b>Specific Keys</b>	
Wireless Button	Wireless enable/disable
E-mail Button	Launch Outlook Express
Bluetooth Button	Enable/disable bluetooth
Internet Button	Launch Internet Explorer

**NOTE:** Detail description and definition of application Launch Buttons, please reference the External spec.

### Wireless LAN & Bluetooth Default Setting

	Wireless LAN	Bluetooth
After loading default settings in BIOS	ON	OFF
At Logon Screen	Follows user setting in previous OS session (by ePM or Launch Manager)	Follows user setting in previous OS session (by ePM or Launch Manager).
In OS	Controlled by ePM or Launch Manager.	Controlled by ePM or Launch Manager.

### Power Button

The activity of the power button is as follows:

- If power button is pressed for less than 1 second then nothing happens.
- If power button is pressed for more than 1 second but less than 4 seconds then system would execute User Requested OFF before the system entered into OS.
- If power button is pressed for more than 4 seconds then the notebook will be powered off by power button over-ride feature.
- If OS is running in ACPI mode, the power button acts as the sleep button, and let OS controls the policy of power button which is defined in Power Option under the OS.

### Power Button Over-ride

Holding down the Power Button for 4 seconds will cause an unconditional transfer to the Off state without notifying the operating system.

If press power button for less than 4 seconds, the system will enter suspend to RAM or OFF state according to OS power option setting.

### Lid Switch

This section describes the expected behavior of the system when the lid is opened or closed by the user.

If the system is running under legacy mode:

- Closing the lid will turn off LCD backlight.

If the system is running under ACPI mode:

- The operating system will determine what action to take when the lid is closed. (Windows does not define Lid Open action in Power Option control panel)
- The function of lid close will follow the OS setting in power management (Nothing, standby, Hibernate or

- Power off). However, if the setting is nothing, the backlight must still be turned off when the lid is closed.
- Lid Open action does not resume the system from S3, S4, and S5.

### ***Hard Disk Password Function/ Password on boot function***

This feature allows the user to set the password to prevent any unauthorized access to the internal hard disk.

- If the original HDD come from other machine with password protected, the system just show " Enter HDD password [       ]"
- User is required to enter HDD password when system boot up.
  - If user enter the wrong password, it will pop out message "Setup Warning, Invalid Passwrod".....
  - If the password is correct, system will continue to boot up into OS.
- "Password on boot"
  - Password on boot is "Disabled", the system will NOT POP any password prompt windows during POST.
  - If Password on boot is set to "Enabled" , the system will POP "Enter password" prompt windows during POST. No matter the user key in "Supervisor Password" or "User Password", the system will be unlocked.

### ***Valid Password Characters***

Valid Password Characters:

Symbol Character	Symbol Name
A-Z	Alphabets A through Z (Not Case Sensitive)
0-9	Numerical Characters
-	Dash
=	Equal Sign
[	Left Bracket
]	Right Bracket
.	Period
,	Comma
;	Semi-Colon
/	Slash
\	Back-slash



# Information

Insyde Software SCU		May 20, 2003 5:40:09 AM		
Main	Advanced	Security	Boot	Exit

<pre> -----Devices----- Product Name      = Aspire 9500 Manufacture Name  = Acer BIOS Version      = V1.00 VGA Version       = 3104  HDD Model Name = HITACHI_DK23EA-40-(PM) HDD Serial Number = 123456789 ATAPI Model Name = UJDA740 DVD/CDROM-(SM)  Serial Number = ( 32 bytes) Asset Tag Number = (32 bytes) UUID = (16 bytes)                 </pre>	<pre> -----System----- CPU = Intel® Pentium ® 4 CPU speed = 2.0 GHz L2 Cache = 2048 KB  -----Memory----- System Memory      = 640 KB Extended Memory    = 256MB VGA Memory         = 128 MB                 </pre>
--	--

Setup system date, time. Enable boot logo and get system information.

Parameter	Description
Product Name	This field will show the product name
Manufacture Name	This field will show manufacturer name
BIOS Version	This field reports the BIOS version of system
VGA Version	This field reports the VGA version of the system
HDD Model Name	This item will show the Model name of HDD installed on Primary IDE master. The hard disk model name is automatically detected by the system. If there is no hard disk present or unknown type, "None" should be shown on the field.
HDD Serial Number	This item will show the Serial number of HDD installed on Primary IDE master. If no Hard disk or other devices are installed on Primary IDE master, then it will display a blank line
ATAPI Model Name	This field shows the ATAPI Model Name for you
Serial Number	This item will show the Serial number of system
Asset Tag	This item will show the Asset Tag number of the system
UUID	This will be visible only when there is an internal LAN device present
System Memory	This field reports the memory size of system base memory. The size is fixed to 640KB.
Extended Memory	This field reports the memory size of the extended memory in the system. Extended Memory size = Total memory size - 1 MB

---

Parameter	Description
Video Memory	VGA Memory size : Discrete = 64 or 128MB (depends on actual VRAM size) TurboCache = 32MB (actual TurboCache VRAM size) Intel 915 DVMT: selectable between the following: <ol style="list-style-type: none"><li data-bbox="678 352 1195 384">1. 64MB (8MB pre-allocated + 56MB DVMT)</li><li data-bbox="678 396 1414 457">2. 128MB (8MB pre-allocated + 128DVMT). <b>This is the default value.</b></li><li data-bbox="678 470 1382 531">3. Max DVMT (160MB on 256MB system memory, 224MB on 512MB and above system memory).</li></ol>

# Main

This menu provides you the information of the system.the is

Insyde Software SCU		May 20, 2003	5:40:09	AM
Main	Advanced	Security	Boot	Exit
Date and Time	<div style="border: 1px solid black; padding: 10px; text-align: center;"> <p>-----Power On Display-----</p> <div style="border: 1px solid black; padding: 5px; margin: 10px auto; width: 80%;"> <p>( ) Auto</p> <p>( ) Both</p> </div> <p>OK                      Cancel</p> </div>			
Power On Display				
v Quiet Boot				
v LCD Auto DIM				
_ Network Boot				
_ F12 Boot Menu				
v D2D Recovery				
<p>Press &lt;Tab&gt; key to select a control. &lt;OK&gt; button or &lt;Enter&gt; key accept entries. &lt;Cancel&gt; button or &lt;Esc&gt; key reject entries. Use cursor, spacebar, and numeric keys to change values. &lt;Alt&gt; key activates accelerators.</p>				

Insyde Software SCU		May 20, 2003	5:40:09	AM
Main	Advanced	Security	Boot	Exit
Date and Time				
Power On Display				
v Quiet Boot				
v LCD Auto DIM				
_ Network Boot				
_ F12 Boot Menu				
v D2D Recovery				
<p>Enable or disable the F12 key for Boot Menu during POST &lt;Space&gt; for select</p>				

Parameter	Description	Option
Date and Time	The hours are displayed with 12 hour format. The values set in these two fields take effect immediately	
Power On Display	<b>AUTO:</b> if select "AUTO" item will let BIOS to select either one Display on screen. <b>BOTH:</b> Select "Both" item the display mode will be select on twin mode.	
Quiet Boot	<b>Enabled:</b> Customer Logo is displayed, and Summary Screen is disabled <b>Disabled:</b> Customer Logo is not displayed, and Summary Screen is enabled.	
Network Boot	When this is selected, Boot from LAN feature is enabled. When this is not selected, Boot from LAN feature is then disabled.	
LCD Auto Dim	The system will support an automatic dimming of the LCD backlight when the AC power is NOT available (running on battery power)	<b>Enabled:</b> LCD brightness will automatically lower to save more power when AC is not present. <b>Disabled:</b> LCD brightness will NOT automatically lower to save more power when AC is not present.
F12 Boot Menu	<b>Enabled:</b> During user's quite boot, the OEM POST screen will have "Press <F12>Change Boot Device" <b>Disabled:</b> During user's quite boot, the OEM POST screen will not have "Press <F12>Change Boot Device"	
D2D Recovery	<b>Enabled:</b> Enable D2D Recovery/eRecovery <b>Disabled:</b> Disable D2D Recovery/eRecovery	

## Advanced

The Advanced screen contains parameters involving your hardware devices. It also provides advanced settings of the system.

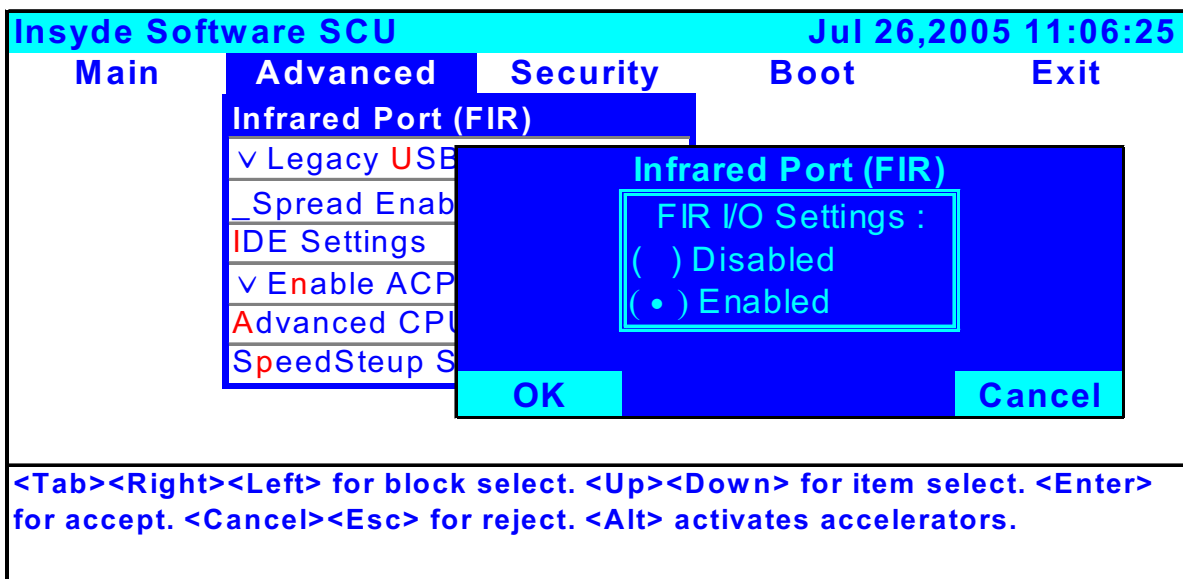
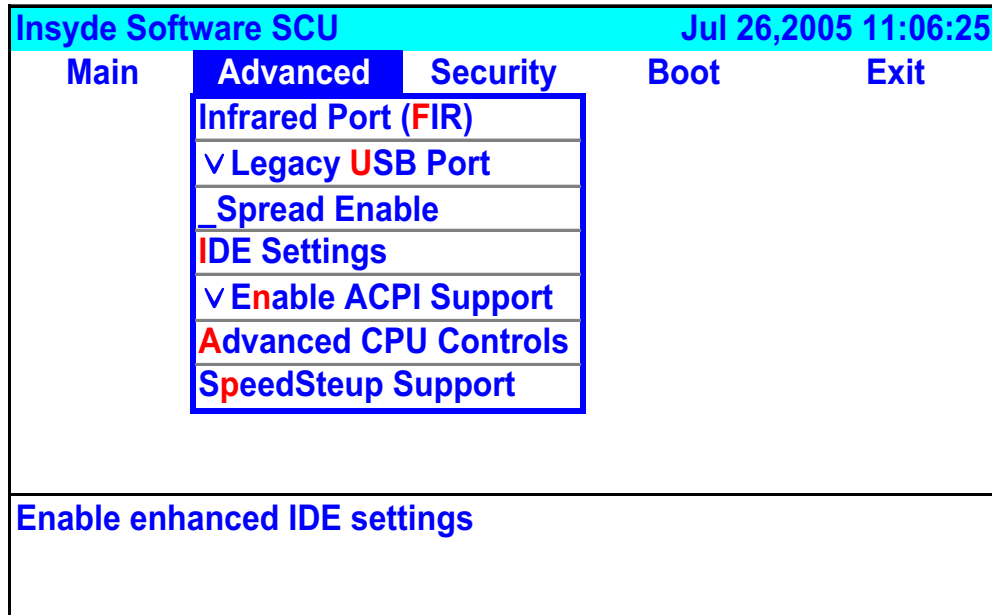

The table below describes the parameters in the screen. Settings in **boldface** are the default and suggested parameter settings.

	Description	Option
<b>Infrared Port (FIR)</b>		
FIR I/O Settings	Sets the base I/O address and IRQ for Infrared port.	Disabled Enabled

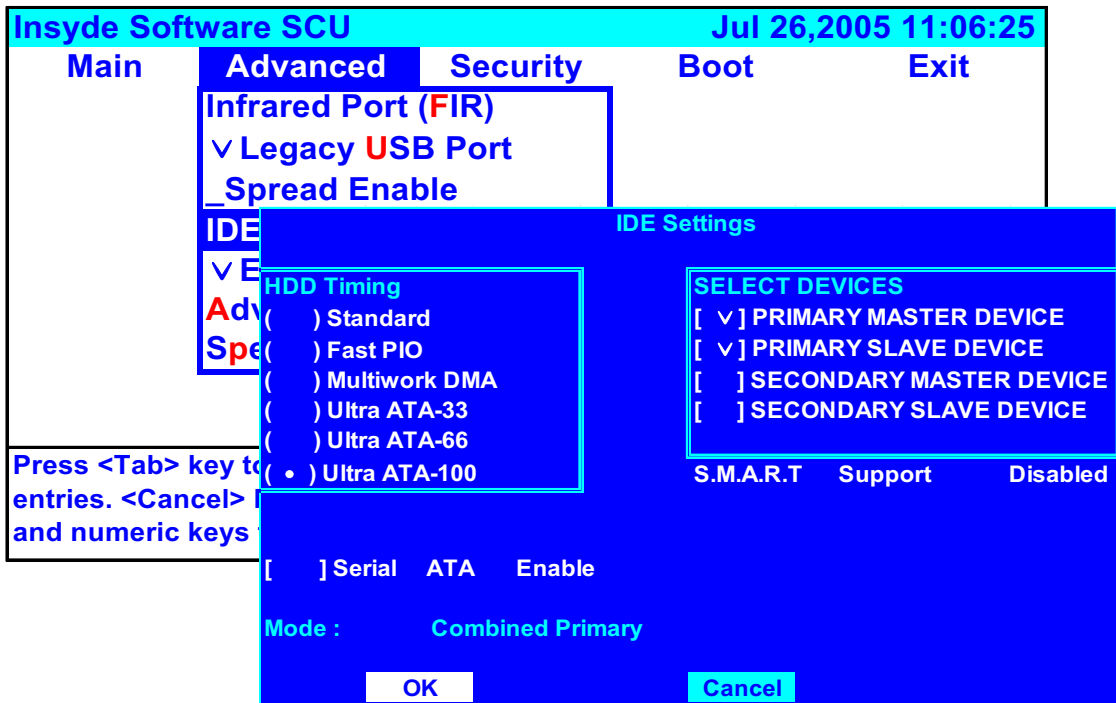

Enable enhanced IDE settings

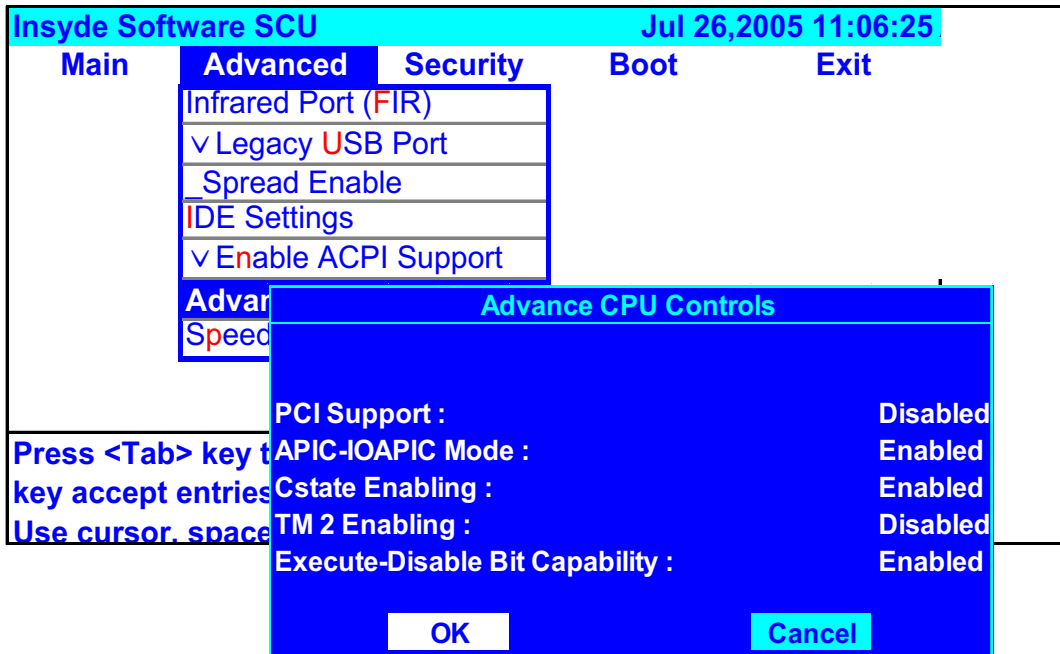

Set Processor Controls

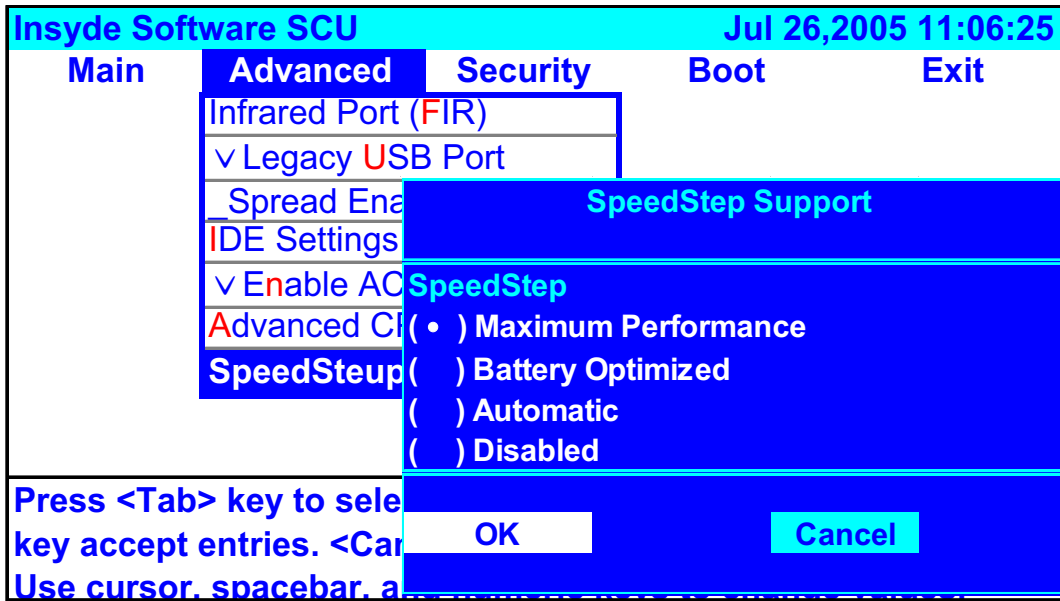

Enable SpeedStep Supports

## Security

The Security screen contains parameters that help safeguard and protect your computer from unauthorized use.

Insyde Software SCU		May 20, 2003 5:40:09 AM	
Main	Advanced	Security	Boot Exit
	Set User Password		
	Set Supervisor Password		
	Lock HardDisk Drive		
		-----Set Supervisor password-----	
		Enter old Supervisor password: .....	
		Enter new Supervisor Password: .....	
		Verify new Supervisor Password: .....	
		[ ] Boot System	
		OK	Cancel

Enter new password. Password will NOT be displayed

If password on boot is required, the password must be set otherwise it cannot be enabled.

The formats of the password are as follows:

- Length 10 characters
- Characters Alphanumeric keys only. The shift status i.e. Ctrl, Shift, Alt and Capital are ignored.

The table below describes the parameters in this screen. Settings in **boldface** are the default and suggested parameter settings.

Parameter	Description
Set User Password	Defines whether a password is required or not while the events defined in this group happened. The following sub-options are all requires the Supervisor password for changes and should be grayed out if the user password was used to enter setup. When you set Supervisor password already and then you reboot and into BIOS setup manual by User password, the set Supervisor password, Boot device and Lock Hard Drive will be disable. Allows the user to specify whether or not a password is required to boot.
Set Supervisor Password	
Lock Hard Disk Drive	Set the password to lock the hard disk drive



## Boot

This menu allows the user to decide the order of boot devices to load the operating system. Bootable devices includes the distette drive in module bay, the onboard hard disk drive and the CD-ROM in module bay and onboard LAN device.

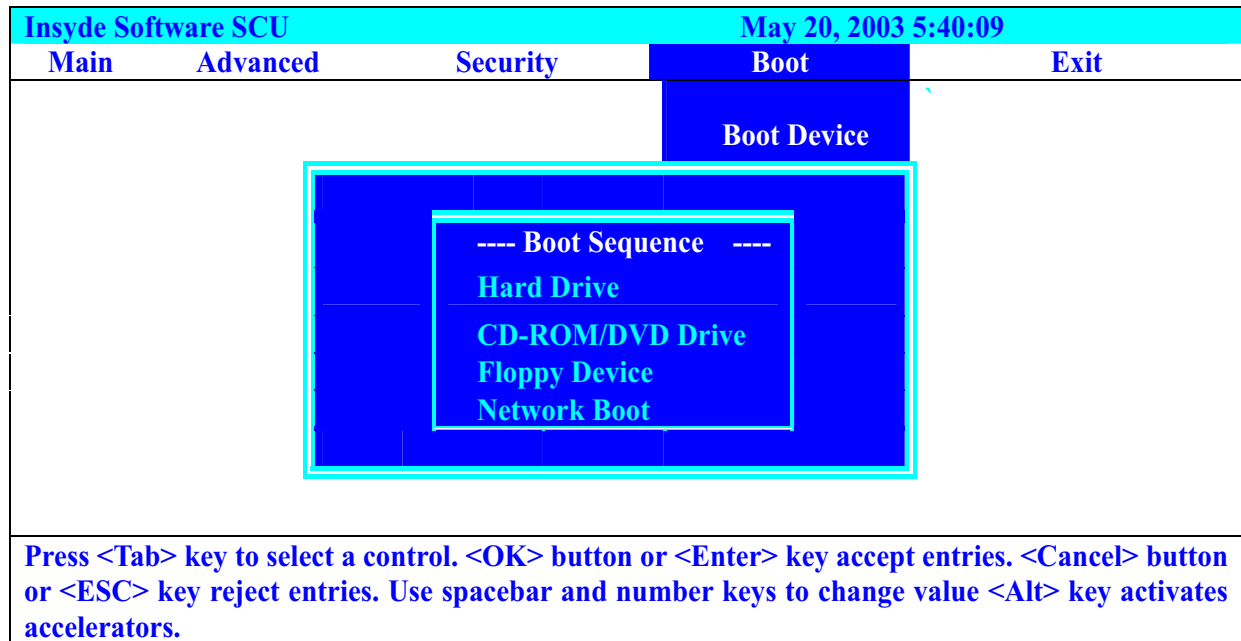

Default boot sequence should be the following:

1. Hard Drive
2. CD-ROM/DVD Drive
3. Floppy Drive
4. Network Boot (since only 3 items are available, if above 3 items are invalid, a boot menu should be shown when boot.)

# Exit

The Exit screen contains parameters that help safeguard and protect your computer from unauthorized use.

Insyde Software SCU				Nov 26, 2003 5:40:09	
Main	Advanced	Security	Boot	Exit	
				Exit Saving Changes	
<div style="border: 2px solid red; padding: 10px; text-align: center;"> <p>-----Exit Saving Changes-----</p> <p>Press &lt;OK&gt; to save the current Setup parameters to CMOS RAM.</p> <p>The system will reboot!!!</p> <div style="display: flex; justify-content: space-around; margin-top: 10px;"> <span style="border: 1px solid black; padding: 5px 15px;">OK</span> <span style="border: 1px solid black; padding: 5px 15px; background-color: red;">Cancel</span> </div> </div>				Exit Discarding Changes	
				Load Setup Defaults	
				Discard Changes	
<p>&lt;Tab&gt; &lt;Right&gt; &lt;Left&gt; for block select. &lt;Up&gt; &lt;Down&gt; for item select.          &lt;Enter&gt; for accept. &lt;Cancel&gt; &lt;Esc&gt; for reject. &lt;Alt&gt; activates accelerators.          &lt;Space&gt; for Enable or Disable.</p>					

Insyde Software SCU				May 20, 2003 5:40:09	
Main	Advanced	Security	Boot	Exit	
				Exit Saving Changes	
<div style="border: 2px solid red; padding: 10px; text-align: center;"> <p>-----Exit Discarding Changes-----</p> <p>Press &lt;OK&gt; to Exit the SCU.</p> <p>The current settings will not be saved!!!</p> <div style="display: flex; justify-content: space-around; margin-top: 10px;"> <span style="border: 1px solid black; padding: 5px 15px;">OK</span> <span style="border: 1px solid black; padding: 5px 15px; background-color: red;">Cancel</span> </div> </div>				Exit Discarding Changes	
				Load Setup Defaults	
				Discard Changes	
<p>&lt;Tab&gt; &lt;Right&gt; &lt;Left&gt; for block select. &lt;Up&gt; &lt;Down&gt; for item select.          &lt;Enter&gt; for accept. &lt;Cancel&gt; &lt;Esc&gt; for reject. &lt;Alt&gt; activates accelerators.          &lt;Space&gt; for Enable or Disable.</p>					

Insyde Software SCU				May 20, 2003 5:40:09
Main	Advanced	Security	Boot	Exit
<div style="border: 2px solid cyan; padding: 10px; text-align: center;"> <p>-----Load Setup Default-----</p> <p>Do you wish to change the current setup to the system default values?</p> <p><input type="button" value="OK"/> <input type="button" value="Cancel"/></p> </div>				Exit <b>S</b> aving Changes
				Exit <b>D</b> iscarding Changes
				Load Setup Defaults
				Discard <b>C</b> hanges
<p>&lt;Tab&gt; &lt;Right&gt; &lt;Left&gt; for block select. &lt;Up&gt; &lt;Down&gt; for item select.            &lt;Enter&gt; for accept. &lt;Cancel&gt; &lt;Esc&gt; for reject. &lt;Alt&gt; activates accelerators.            &lt;Space&gt; for Enable or Disable.</p>				

Insyde Software SCU				May 20, 2003 5:40:09
Main	Advanced	Security	Boot	Exit
<div style="border: 2px solid cyan; padding: 10px; text-align: center;"> <p>-----Discard Changes-----</p> <p>Do you wish to restore the current setup to the original custom values?</p> <p><input type="button" value="OK"/> <input type="button" value="Cancel"/></p> </div>				Exit <b>S</b> aving Changes
				Exit <b>D</b> iscarding Changes
				<b>L</b> oad Setup Defaults
				Discard <b>C</b> hanged
<p>&lt;Tab&gt; &lt;Right&gt; &lt;Left&gt; for block select. &lt;Up&gt; &lt;Down&gt; for item select.            &lt;Enter&gt; for accept. &lt;Cancel&gt; &lt;Esc&gt; for reject. &lt;Alt&gt; activates accelerators.            &lt;Space&gt; for Enable or Disable.</p>				

## ***Machine Disassembly and Replacement***

---

This chapter contains step-by-step procedures on how to disassemble the notebook computer for maintenance and troubleshooting.

To disassemble the computer, you need the following tools:

- Wrist grounding strap and conductive mat for preventing electrostatic discharge
- small phillips screwdriver
- flat head screwdriver
- Phillips screwdriver
- Hex screwdriver

**NOTE:** The screws for the different components vary in size. During the disassembly process, group the screws with the corresponding components to avoid mismatch when putting back the components.

When you remove the stripe cover, please be careful not to scrape the cover.

---

## ***General Information***

### ***Before You Begin***

Before proceeding with the disassembly procedure, make sure that you do the following:

1. Turn off the power to the system and all peripherals.
  - a. Save and close any open files, exit any open programs, click the **Start** button, and then click **Turn Off Computer**.
  - b. In the **Turn off computer** window, click **Turn off**. The computer turns off after the operating system shutdown process finishes
2. Unplug the AC adapter and all power and signal cables from the system.
3. Ensure that the computer and any attached devices are turned off. If your computer and attached devices did not automatically turn off when you shut down your operating system, press and hold the power button for at least 8 ~10 seconds until the computer turns off.

---

## ***Aspire 9500 Disassembly Procedure***

This section will guide you how to disassemble the system when you need to perform system service. Please also refer to the disassembly video, if available.

**CAUTION:** Before you proceed, be sure you have turned off the system and all peripherals connected.

### ***Disassemble the Battery and HDD***

1. Slide and hold the battery-bay latch release on the bottom of the system, and then remove the battery from the bay.
2. Turn the system over, and remove the hard drive screws.
3. Slide the hard drive out of the system.

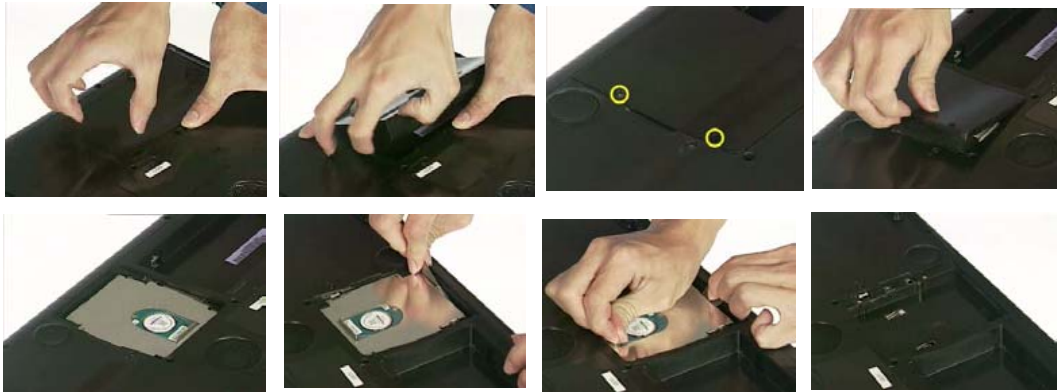

### ***Disassemble the TV Tuner and Wireless***

1. Loosen the one screw to from the Wireless door
2. Place your finger under the cover at the indentation and lift the cover open.
3. Release the TV Tuner card by spreading the metal securing tabs until the card pops up slightly.
4. Disconnect the TV Tuner cable.



5. Tear the tape before you conduct the next step.
6. Disconnect the antenna cables from the Mini PCI card.
7. Release the Mini PCI card by spreading the metal securing tabs until the card pops up slightly.
8. Lift the Mini PCI card out of its connector.



### ***Disassemble the CPU Heatsink***

1. Remove the two screws and detach the door.
2. Remove the three screws to detach the CPU fan.



3. Remove the four screws.
4. Detach the CPU heatsink.



### ***Disassemble the RAM and ODD***

1. Remove the one screw to release the RAM door.
2. Detach the RAM door.
3. Use your fingertips to carefully spread apart the securing clips on each end of the memory module connector until the module pops up.

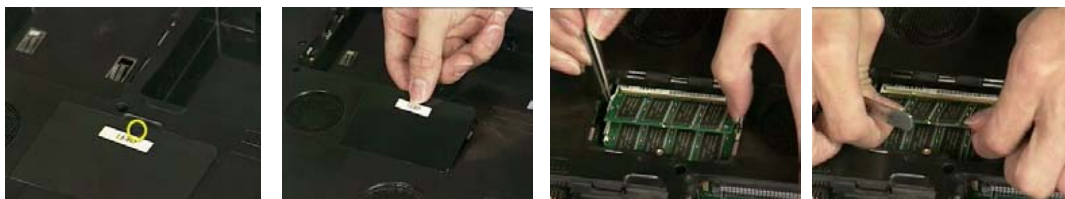

4. Remove the one screw to release the ODD door.
5. Push the ODD bracket from the ODD rear to push it outward from the system.
6. Then pull the ODD out from the system.



7. Detach the bezel from the ODD.



### ***Disassemble the Power Board, Bluetooth and Keyboard***

1. Insert a scribe into the indent to lift the hinge cover on the right side.
2. Ease the hinge cover up, moving from right to left, and remove it.
3. Remove the screw securing the power board to the system board, and set it aside.



4. Disconnect the bluetooth cable from the routing channels with the tapes following system board.
5. Before you detach the bluetooth, you have to detach the right speaker first.

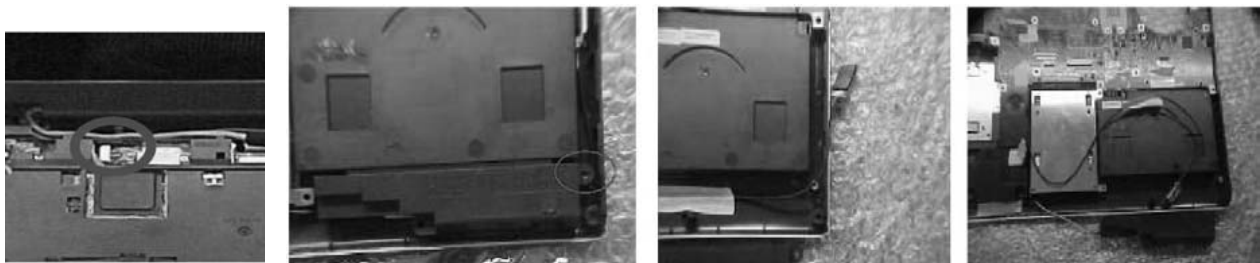



6. Remove the three screws at the top of the keyboard.
7. Lift up the keyboard and hold it up and slightly forward to allow access to the keyboard connector.
8. Pull up on the keyboard connector pull-tab to disconnect the keyboard connector from the system board.



### ***Disassemble the Cables, Antenna and LCD Module***

1. Disconnect the touchpad cable and CD-Player cable.
2. Disconnect the wire cable from the board.

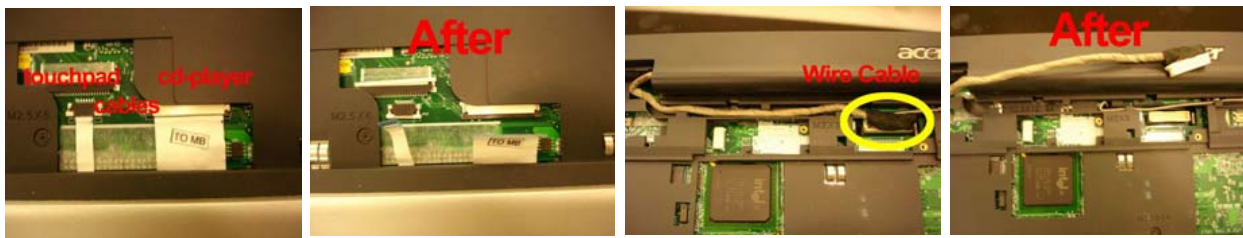

3. Disconnect the Antenna cable.



4. Tear the tape then pull the antenna cables from the routing channels.

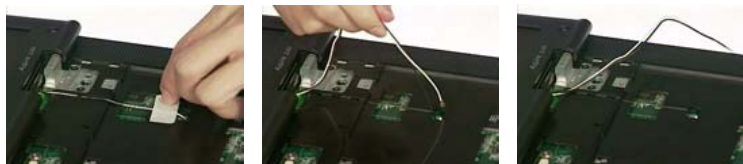

5. Loosen the two screws on each side as shown here.

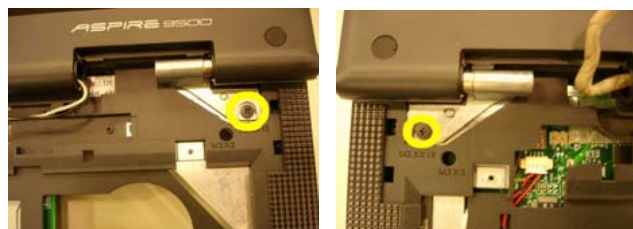

6. Remove another two screws located on the each side of the rear side.
7. Then detach the LCD module from the system.

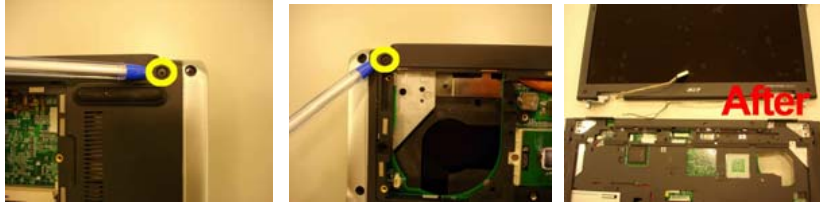

### ***Disassemble Case, Touchpad and CD-Player***

1. Remove the three screws located on the upper case as shown.
2. Remove those five screws located on the upper case as shown.

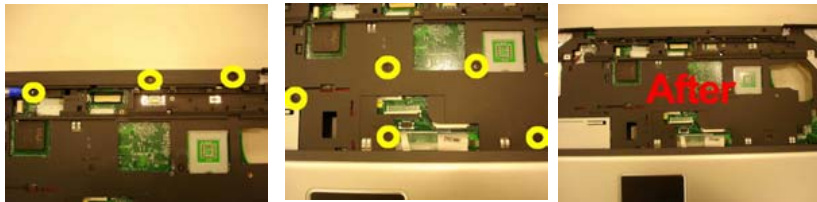

3. Turn the system over and loosen the five screws from the edge of the system.
4. Remove the seven screws as shown.

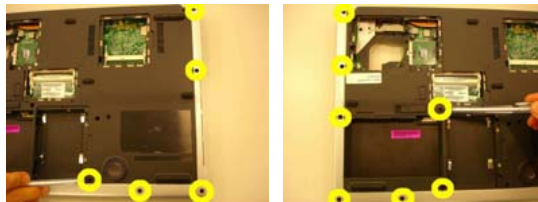

5. Disconnect the MIC. cable from here.



6. Tear the tape and disconnect the CD-Player FFC.

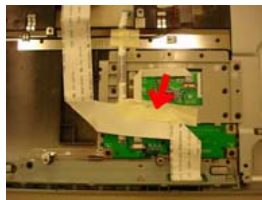

7. Remove the two screws securing the touchpad board support.

- Detach it from the system.

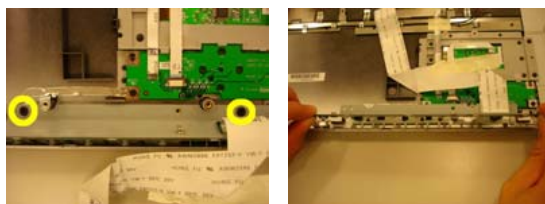

- Disconnect the power board cable from the touchpad board.

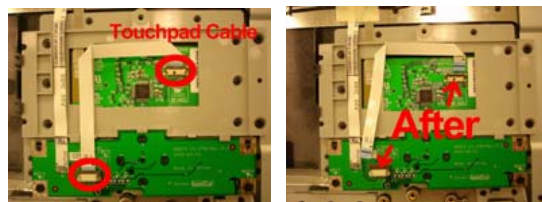

- Remove the two screws securing the power board.

- Detach it from the position.

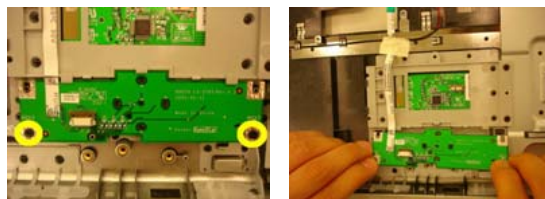

- Remove the two screws as shown.
- Be aware of indentation positions to unhook the touchpad support.
- Detach the touchpad support from the system.
- Gently detach the touchpad board from the system.

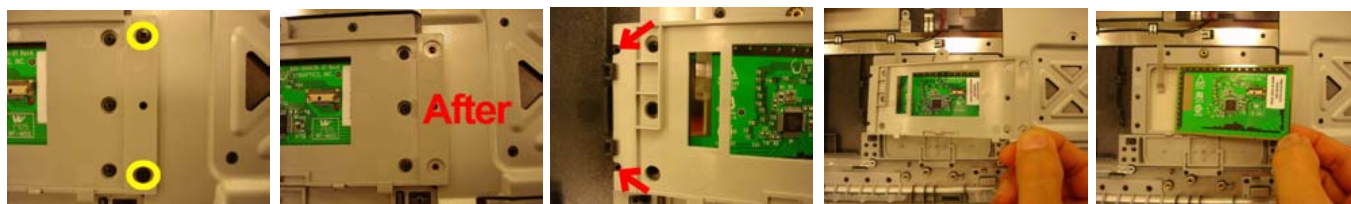

### ***Disassemble the Mainboard***

- Disconnect the sub-woofer and speaker cable from mainboard.
- Remove the one screw securing the mainboard.
- Remove the six hex screws from the rear of the mainboard.
- Detach the mainboard from the case.



---

## ***Disassemble the VGA and Modem board***

1. Remove the two screws securing the VGA board.
2. Turn the VGA over and loosen the three screws from the VGA thermal.
3. Separate the VGA thermal from the VGA board.



4. Remove the one screw securing the modem board.
5. Disconnect the modem cable from the position.
6. Detach the modem board from the mainboard.



## ***Disassemble the CPU***

1. With a flat screwdriver to loosen the CPU.
2. Detach the CPU from the mainboard.

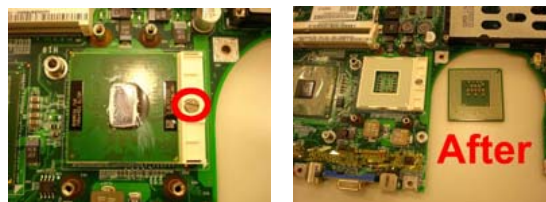

## ***Disassemble the LCD Module***

1. Remove the four screws on the other side to release the LCD front bezel.
2. Detach the front bezel from the LCD panel.
3. Disconnect the inverter cable from the inverter board.
4. Disconnect the LCD cable from the inverter board.



5. Remove the one screw.
6. Then detach the inverter board from the LCD panel module.
7. Remove the one screw on each bracket to release the bracket from the LCD module.
8. Take the entire LCD panel out from the top cover.

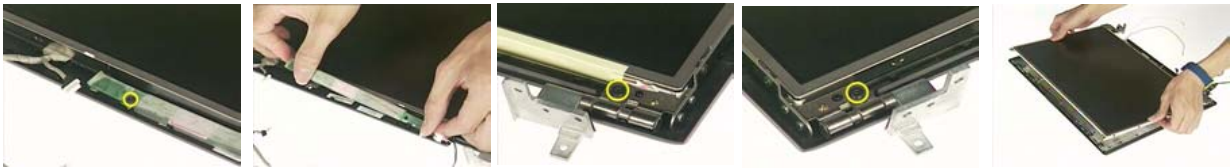

9. Remove the four screws to detach the bracket.
10. Then take the LCD bracket from the panel.
11. Remove another four screws to release the bracket.
12. Then detach the bracket out from the LCD Panel.
13. Tear the tapes as video guides you from the LCD wire set cable and disconnect it from the panel.

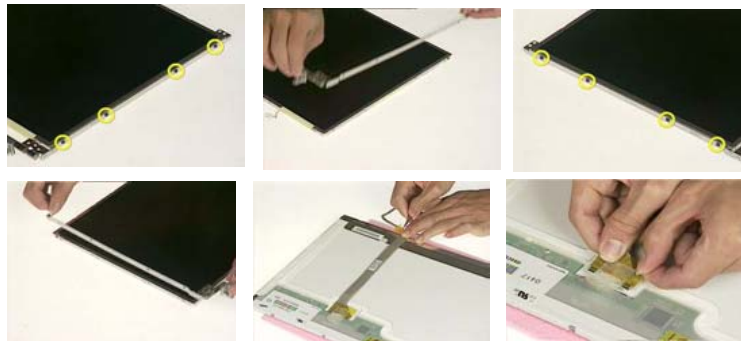

## Troubleshooting

Use the following procedure as a guide for computer problems.

1. Obtain the failed symptoms in as much detail as possible.
2. Verify the symptoms by attempting to re-create the failure by running the diagnostic test or by repeating the same operation.
3. If any problem occurs, you can perform visual inspection before you follow this chapter's instructions.

You can check the following:

- power cords are properly connected and secured;
- there are no obvious shorts or opens;
- there are no obviously burned or heated components;
- all components appear normal.

4. After you perform visual inspection you can also verify the following:
  - ask the user if a password is registered and, if it is, ask him or her to enter the password.
  - verify with the customer that Windows XP is installed on the hard disk. Operating systems that were not preinstalled by Acer can cause malfunction.
  - make sure all optional equipment is removed from the computer.
  - make sure the floppy disk is empty.
5. Use the following table with the verified symptom to determine which page to go to.

Symptoms (Verified)	Go To
Power failure. (The power indicator does not go on or stay on.)	"Power System Check"
POST does not complete. No beep or error codes are indicated.	"Insyde MobilePro BIOS POST Beep Code and POST Messages" "Undetermined Problems"
POST detects an error and displayed messages on screen.	"Insyde MobilePro BIOS POST Beep Code and POST Messages"
Other symptoms (i.e. LCD display problems or others).	"Insyde MobilePro BIOS POST Beep Code and POST Messages"
Symptoms cannot be re-created (intermittent problems).	Use the customer-reported symptoms and go to "Insyde MobilePro BIOS POST Beep Code and POST Messages" on page 67 "Intermittent Problems" "Undetermined Problems"

---

# ***System Check Procedures***

## ***External Diskette Drive Check***

Do the following steps to isolate the problem to a controller, driver, or diskette. A write-enabled, diagnostic diskette is required.

**NOTE:** Make sure that the diskette does not have more than one label attached to it. Multiple labels can cause damage to the drive or cause the drive to fail.

Do the following to select the test device.

1. The FDD heads can become dirty over time, affecting their performance. Use an FDD cleaning kit to clean the heads. If the FDD still does not function properly after cleaning, go to next step.
2. Boot from diagnostic program.
3. If an error occurs with the internal diskette drive, reconnect the diskette connector on the main board.

If the error still remains:

1. Reconnect the external diskette drive module.
2. Replace the external diskette drive module.
3. Replace the main board.

## ***External CD-ROM/DVD-ROM Drive Check***

Do the following to isolate the problem to a controller, drive, or CD-ROM/DVD-ROM. Make sure that the CD-ROM does not have any label attached to it. The label can cause damage to the drive or can cause the drive to fail.

Do the following to select the test device:

1. Insert an audio CD into the CD/DVD drive. If the CD/DVD drive can read the data from the audio CD. The drive does not have problem, then go to next step. If the CD/DVD LED on the front panel does not emit light as it read the data from the audio CD, then go to next step. However, if the CD/DVD drive can not read data from the audio CD, you may need to clean the CD/DVD drive with a CD/DVD drive cleaning disk.
2. Make sure that the appropriate driver has been installed on the computer for the CD/DVD drive.
3. Boot from the diagnostics diskette and start the diagnostics program
4. See if CD-ROM Test is passed when the program runs to CD-ROM/DVD-ROM Test.
5. Follow the instructions in the message window.

If an error occurs, reconnect the connector on the main board. If the error still remains:

1. Reconnect the CD-ROM/DVD-ROM module.
2. Replace the CD-ROM/DVD-ROM module.
3. Replace the main board.

---

## ***Keyboard or Auxiliary Input Device Check***

Remove the external keyboard if the internal keyboard is to be tested.

If the internal keyboard does not work or an unexpected character appears, make sure that the flexible cable extending from the keyboard is correctly seated in the connector on the main board.

If the keyboard cable connection is correct, run the Keyboard Test.

If the tests detect a keyboard problem, do the following one at a time to correct the problem. Do not replace a non-defective FRU:

1. Reconnect the keyboard cables.
2. Replace the keyboard.
3. Replace the main board.

The following auxiliary input devices are supported by this computer:

- Embedded Numeric Keypad
- External keyboard

If any of these devices do not work, reconnect the cable connector and repeat the failing operation.

## ***Memory Check***

Memory errors might stop system operations, show error messages on the screen, or hang the system. Currently, we do not provide memory test program. However, if you need to check memory but have no testing program or diagnostic utility at hand, please go to <http://www.passmark.com> to download the shareware "BurnIn Test V.3.0". You may test the memory with this program under Window XP environment.

**NOTE:** Make sure that the DIMM is fully installed into the connector. A loose connection can cause an error.

## ***Power System Check***

To verify the symptom of the problem, power on the computer using each of the following power sources:

1. Remove the battery pack.
2. Connect the power adapter and check that power is supplied.
3. Disconnect the power adapter and install the charged battery pack; then check that power is supplied by the battery pack.

If you suspect a power problem, see the appropriate power supply check in the following list:

- "Check the Power Adapter"
- "Check the Battery Pack"



---

## Check the Power Adapter

Unplug the power adapter cable from the computer and measure the output voltage at the plug of the power adapter cable. See the following figure

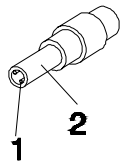

Pin 1: 19V  
Pin 2: 0V, Ground

1. If the voltage is not correct, replace the power adapter.
2. If the voltage is within the range, do the following:
  - Replace the main board.
  - If the problem is not corrected, see “Undetermined Problems”.
  - If the voltage is not correct, go to the next step.

**NOTE:** An audible noise from the power adapter does not always indicate a defect.

3. If the DC-IN indicator does not light up, check the power cord of the power adapter for correct continuity and installation.
4. If the operational charge does not work, see “Check the Power Adapter” .

---

## ***Check the Battery Pack***

To check the battery pack, do the following:

From Software:

1. Check out the Power Options in control Panel
2. In Power Meter, confirm that if the parameters shown in the screen for Current Power Source and Total Battery Power Remaining are correct.
3. Repeat the steps 1 and 2, for both battery and adapter.
4. This helps you identify first the problem is on recharging or discharging.

From Hardware:

1. Power off the computer.
2. Remove the battery pack and measure the voltage between battery terminals 1(+) and 6(ground).
3. If the voltage is still less than 7.5 Vdc after recharging, replace the battery.
4. If the voltage is within the normal range, run the diagnostic program.

To check the battery charge operation, use a discharged battery pack or a battery pack that has less than 50% of the total power remaining when installed in the computer.

If the battery status indicator does not light up, remove the battery pack and let it return to room temperature. Re-install the battery pack.

If the charge indicator still does not emit, replace the battery pack. If the charge indicator still does not light up, replace the DC/DC charger board.

## ***Touchpad Check***

If the touchpad doesn't work, do the following actions one at a time to correct the problem. Do not replace a non-defective FRU:

1. After rebooting, run Touch pad/PS2 Mode Driver.
2. Run utility with the PS/2 mouse function and check if the mouse is working.
3. If the PS/2 mouse does not work, then check if the main board to switch board FPC is connected well.
4. If the main board to switch board FPC is connected well, then check if the touch pad FPC connects to the main board properly.
5. If there is still an error after you have connected the touch pad FPC to the main board properly, then replace the touch pad or touch pad FPC. The touch pad or touch pad FPC may be damaged.
6. Replace switch board.
7. If the touch pad still does not work, then replace the FPC on Track Pad PCB.

After you use the touchpad, the pointer drifts on the screen for a short time. This self-acting pointer movement can occur when a slight, steady pressure is applied to the touchpad pointer. This symptom is not a hardware problem. No service actions are necessary if the pointer movement stops in a short period of time.

## ***Display Check***

1. Connect an external display to the computer's external monitor port, the boot the computer. The computer can automatically detect the external display. Press Fn+  to switch to the external display.
2. If the external display works fine, the internal LCD may be damaged. Then perform the following steps:

Make sure the DDDRAM module is seated properly. Then run the display test again. If the problem still exists, go to next step.

Replace the inverter board, then run the display test program again. If the problem still occurs, go on next step.

Replace the LCD module with a new one then run the display test again. If the problem still happens, continue next step.

Replace LCD/FL cable with a new one then execute the display diagnostic again. If the problem

---

still occurs, continue next step.

Replace the CPU with another of the same specifications. If the problems still occurs, go to next step.

The main board may be damaged. Replace main board.

3. If the external monitor has the same problem as the internal monitor, the main board may be damaged. Please insert the diagnostic disk and run the display test program and go through the sub-steps under step 2.

## ***Sound Check***

To determine if the computer's built-in speakers are functioning properly, perform the following steps. Before you start the steps below, adjust the speaker volume to an appropriate level.

1. Try different audio sources. For example, employ audio CD and digital music file to determine whether the fault is in the speaker system or not. If not all sources have sound problem, the problem is in the source devices. If all have the same problem, continue next step.
2. Connect a set of earphone or external speakers. If these devices work fine, go to next step. If not, then the main board may be defective or damaged. Replace the main board.
3. Follow the disassembling steps in Chapter 3. Ensure the speaker cable is firmly connected to the main board. If the speaker is still a malfunction, go on next step.
4. If the speakers do not sound properly, the speakers may be defective or damaged. Replace the speakers. If the problem still occurs, then replace the main board.

---

## ***PhoenixBIOS POST Tasks and Beep Codes***

When you turn on the PC, the BIOS first performs a number of tasks, called the Power-On-Self-Test (POST). These tasks test and initialize the hardware and then boot the Operating System from the hard disk.

At the beginning of each POST task, the BIOS outputs the test-point error code I/O port 80h. Programmers and technicians use this code during troubleshooting to establish at what point the system failed and what routine was being performed. Some mainboards are equipped with a seven-segment LED display that displays the current value of port 80h. For production boards which do not contain the LED display, you can purchase an installable "Port 80h" card that performs the same function. If the BIOS detects a terminal error condition, it issues a terminal-error beep code (See following), attempts to display the error code on upper left corner of the screen and on the port 80h LED display, and halts POST. It attempts repeatedly to write the error to the screen.

If the system hangs before the BIOS can process the error, the value displayed at the port 80h is the last test performed. In this case, the screen does not display the error code.

---

## ***Terminal POST Errors***

There are several POST routines that require success to finish POST. If they fail, they issue a POST Terminal Error and shut down the system. Before shutting down the system, the error handler issues a beep code signifying the test point error, writes the error to port 80h, attempts to initialize the video, and writes the error in the upper left corner of the screen (using both mono and color adapters).

The routine derives the beep code from the test point error as follows:

1. The 8-bit error code is broken down to four 2-bit groups.
2. Each group is made one -based ( 1 through 4) by adding 1.
3. Short beeps are generated for the number in each group.

**Example:**

**Testpoint 16h=00 01 01 10=1-2-2-3 beeps**

## POST Task Routines

The following is a list of the Test Point codes written to port 80h at the start of each routine, the beep codes issued for terminal errors, and a description of the POST routine. Unless otherwise noted, these codes are valid for PhoenixBIOS.

**NOTE:** The following routines are sorted by their test point numbers assigned in the BIOS code. Their actual order as executed during POST can be quite different.

Code	Beeps	POST Routine Description
02h		Verify Real Mode
03h		Disable Non-Maskable Interrupt (NMI)
04h		Get CPU type
06h		Initialize system hardware
08h		Initialize chipset with initial POST values
09h		Set IN POST flag
0Ah		Initialize CPU registers
0Bh		Enable CPU cache
0Ch		Initialize caches to initial POST values
0Eh		Initialize I/O component
0Fh		Initialize the local bus IDE
10h		Initialize Power Management
11h		Load alternate registers with initial POST values
12h		Restore CPU control word during warm boot
13h		Initialize PCI Bus Mastering devices
14h		Initialize keyboard controller
16h	1-2-2-3	BIOS ROM checksum
17h		Initialize cache before memory autosize
18h		8254 timer initialization
1Ah		8237 DMA controller initialization
1Ch		Reset Programmable Interrupt Controller
20h	1-3-1-1	Test DRAM refresh
22h	1-3-1-3	Test 8742 Keyboard Controller
24h		Set ES segment register to 4 GB
26h		Enable A20 line
28h		Autosize DRAM
29h		Initialize POST Memory Manager
2Ah		Clear 512 KB base RAM
2Ch	1-3-4-1	RAM failure on address line xxxx*
2Eh	1-3-4-3	RAM failure on data bits xxxx* of low byte of memory bus
2Fh		Enable cache before system BIOS shadow
30h	1-4-1-1	RAM failure on data bits xxxx* of high byte of memory bus
32h		Test CPU bus-clock frequency
33h		Initialize Phoenix Dispatch Manager
36h		Warm start shut down
38h		Shadow system BIOS ROM
3Ah		Autosize cache

Code	Beeps	POST Routine Description
3Ch		Advanced configuration of chipset registers
3Dh		Load alternate registers with CMOS values
42h		Initialize interrupt vectors
45h		POST device initialization
46h	2-1-2-3	Check ROM copyright notice
48h		Check video configuration against CMOS
49h		Initialize PCI bus and devices
4Ah		Initialize all video adapters in system
4Bh		QuietBoot start (optional)
4Ch		Shadow video BIOS ROM
4Eh		Display BIOS copyright notice
50h		Display CPU type and speed
51h		Initialize EISA board
52h		Test keyboard
54h		Set key click if enabled
58h	2-2-3-1	Test for unexpected interrupts
59h		Initialize POST display service
5Ah		Display prompt "Press F2 to enter SETUP"
5Bh		Disable CPU cache
5Ch		Test RAM between 512 and 640 KB
60h		Test extended memory
62h		Test extended memory address lines
64h		Jump to UserPatch1
66h		Configure advanced cache registers
67h		Initialize Multi Processor APIC
68h		Enable external and CPU caches
69h		Setup System Management Mode (SMM) area
6Ah		Display external L2 cache size
6Bh		Load custom defaults (optional)
6Ch		Display shadow-area message
6Eh		Display possible high address for UMB recovery
70h		Display error messages
72h		Check for configuration errors
76h		Check for keyboard errors
7Ch		Set up hardware interrupt vectors
7Eh		Initialize coprocessor if present
80h		Disable onboard Super I/O ports and IRQs
81h		Late POST device initialization
82h		Detect and install external RS232 ports
83h		Configure non-MCD IDE controllers
84h		Detect and install external parallel ports
85h		Initialize PC-compatible PnP ISA devices
86h		Re-initialize onboard I/O ports.
87h		Configure Motheboard Configurable Devices (optional)
88h		Initialize BIOS Data Area

Code	Beeps	POST Routine Description
89h		Enable Non-Maskable Interrupts (NMIs)
8Ah		Initialize Extended BIOS Data Area
8Bh		Test and initialize PS/2 mouse
8Ch		Initialize floppy controller
8Fh		Determine number of ATA drives (optional)
90h		Initialize hard-disk controllers
91h		Initialize local-bus hard-disk controllers
92h		Jump to UserPatch2
93h		Build MPTABLE for multi-processor boards
95h		Install CD ROM for boot
96h		Clear huge ES segment register
97h		Fixup Multi Processor table
98h	1-2	Search for option ROMs. One long, two short beeps on checksum failure
99h		Check for SMART Drive (optional)
9Ah		Shadow option ROMs
9Ch		Set up Power Management
9Dh		Initialize security engine (optional)
9Eh		Enable hardware interrupts
9Fh		Determine number of ATA and SCSI drives
A0h		Set time of day
A2h		Check key lock
A4h		Initialize Typematic rate
A8h		Erase F2 prompt
AAh		Scan for F2 key stroke
ACh		Enter SETUP
A Eh		Clear Boot flag
B0h		Check for errors
B2h		POST done - prepare to boot operating system
B4h	1	One short beep before boot
B5h		Terminate QuietBoot (optional)
B6h		Check password (optional)
B9h		Prepare Boot
BAh		Initialize DMI parameters
BBh		Initialize PnP Option ROMs
BCh		Clear parity checkers
BDh		Display MultiBoot menu
BEh		Clear screen (optional)
BFh		Check virus and backup reminders
C0h		Try to boot with INT 19
C1h		Initialize POST Error Manager (PEM)
C2h		Initialize error logging
C3h		Initialize error display function
C4h		Initialize system error handler
C5h		PnPnd dual CMOS (optional)
C6h		Initialize notebook docking (optional)



Code	Beeps	POST Routine Description
C7h		Initialize notebook docking late
C8h		Force check (optional)
C9h		Extended checksum (optional)
D2h		Unknown interrupt

Code	Beeps	For Boot Block in ROM
E0h		Initialize the chipset
E1h		Initialize the bridge
E2h		Initialize the CPU
E3h		Initialize system timer
E4h		Initialize system I/O
E5h		Check force recovery boot
E6h		Checksum BIOS ROM
E7h		Go to BIOS
E8h		Set Huge Segment
E9h		Initialize Multi Processor
EAh		Initialize OEM special code
EBh		Initialize PIC and DMA
ECh		Initialize Memory type
EDh		Initialize Memory size
EEh		Shadow Boot Block
EFh		System memory test
F0h		Initialize interrupt vectors
F1h		Initialize Run Time Clock
F2h		Initialize video
F3h		Initialize System Management Mode
F4h	1	Output one beep before boot
F5h		Boot to Mini DOS
F6h		Clear Huge Segment
F7h		Boot to Full DOS

---

## ***Repair Flowchar***

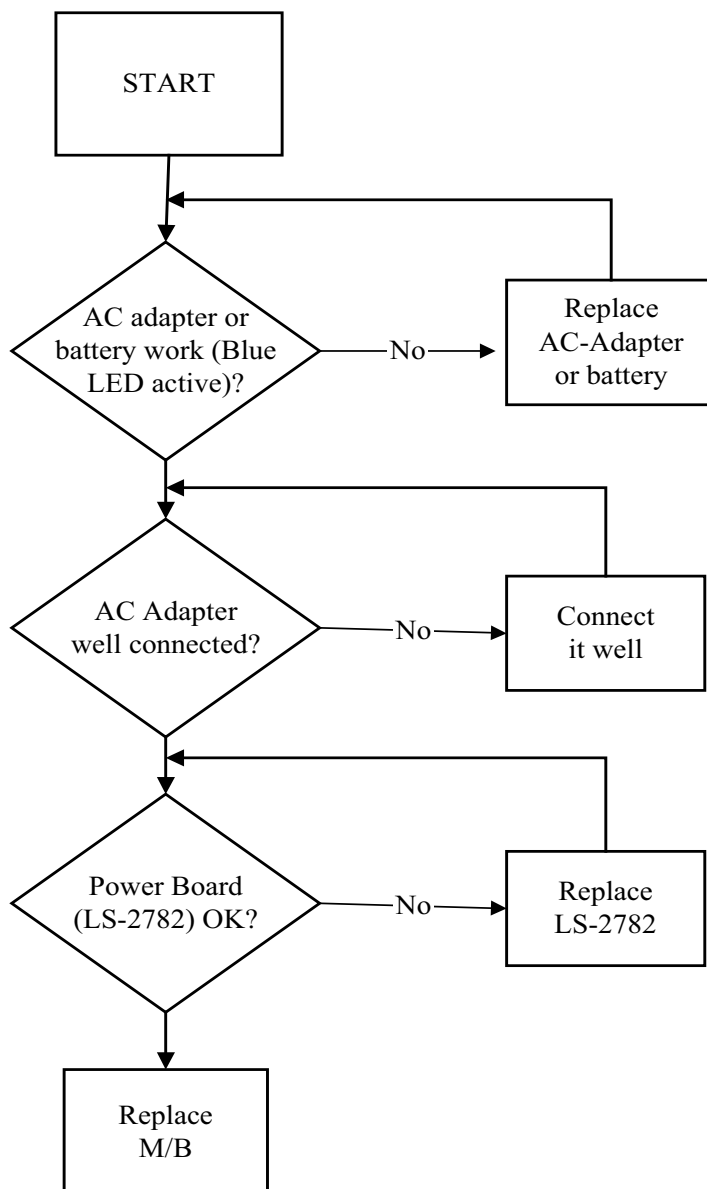

# No Display

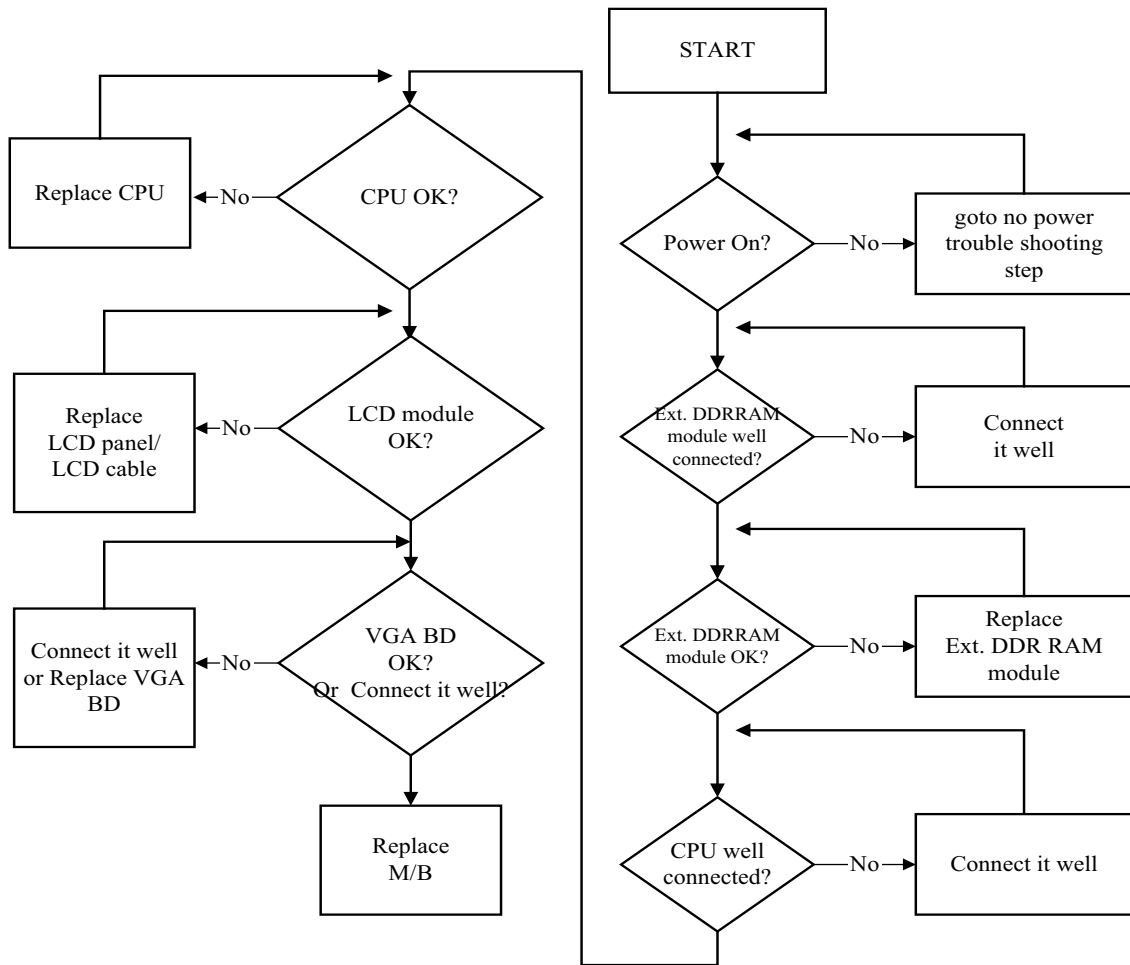

## LCD Picture No Good

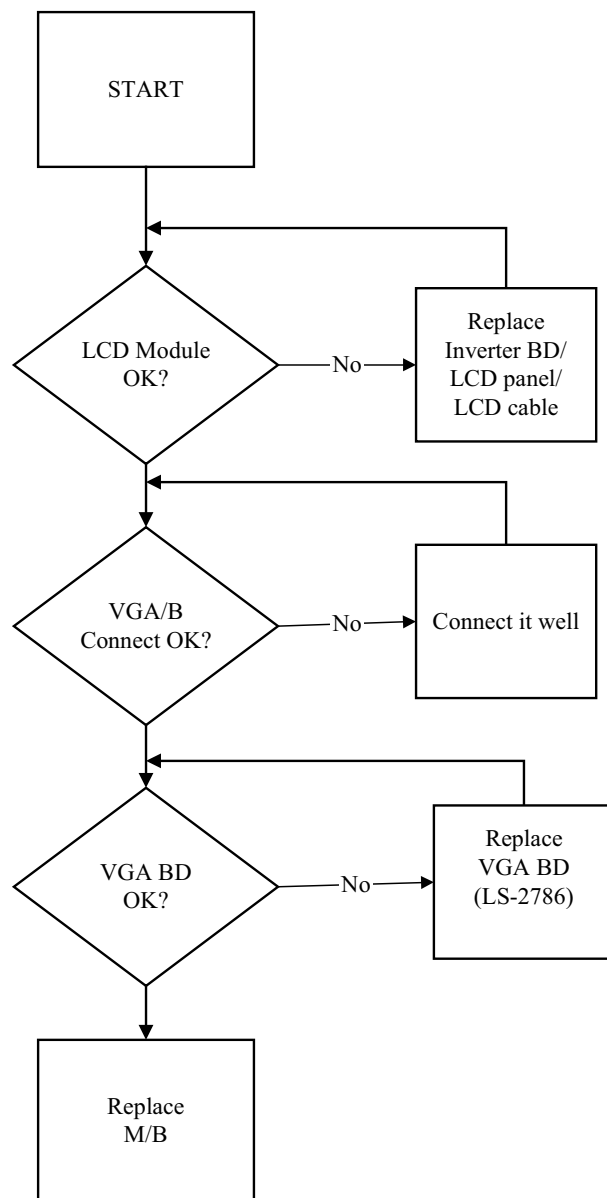

---

## Internal Keyboard Failure

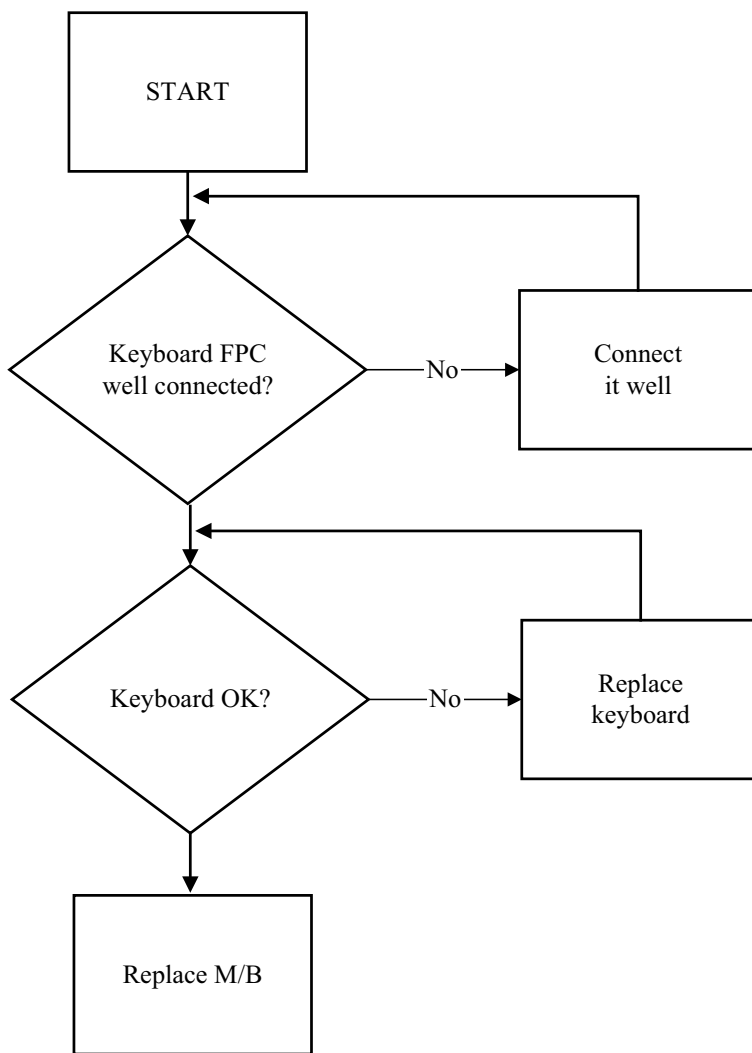

---

## Parallel Port Failure

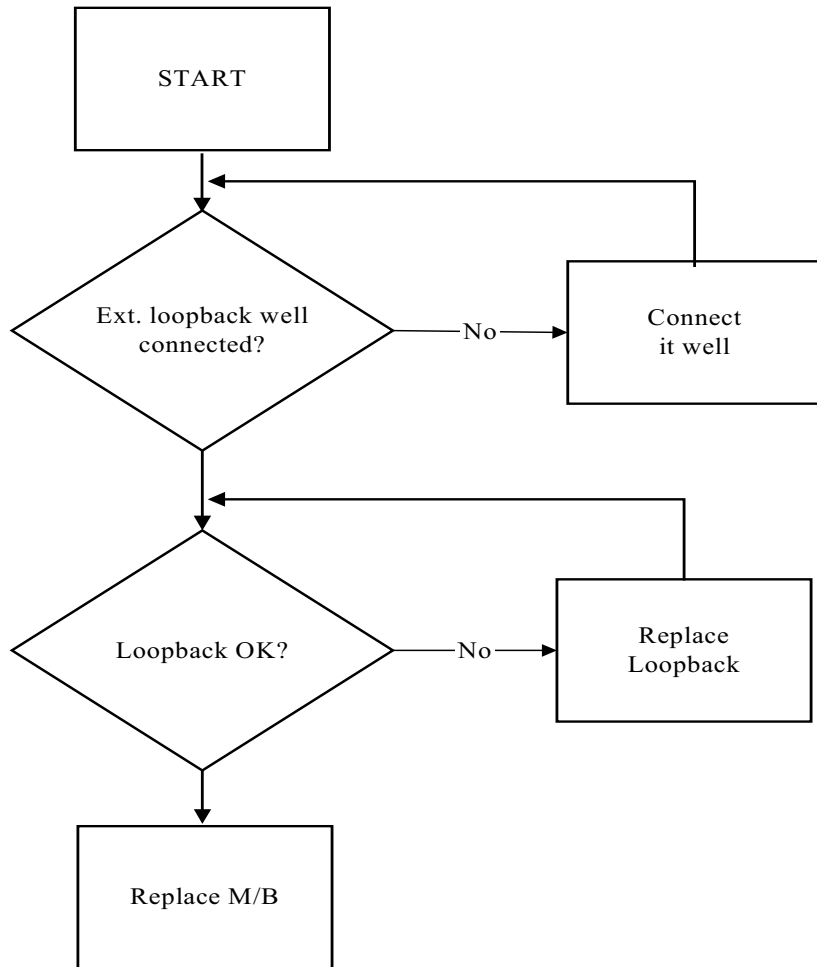

# Touch Pad Mouse Failure

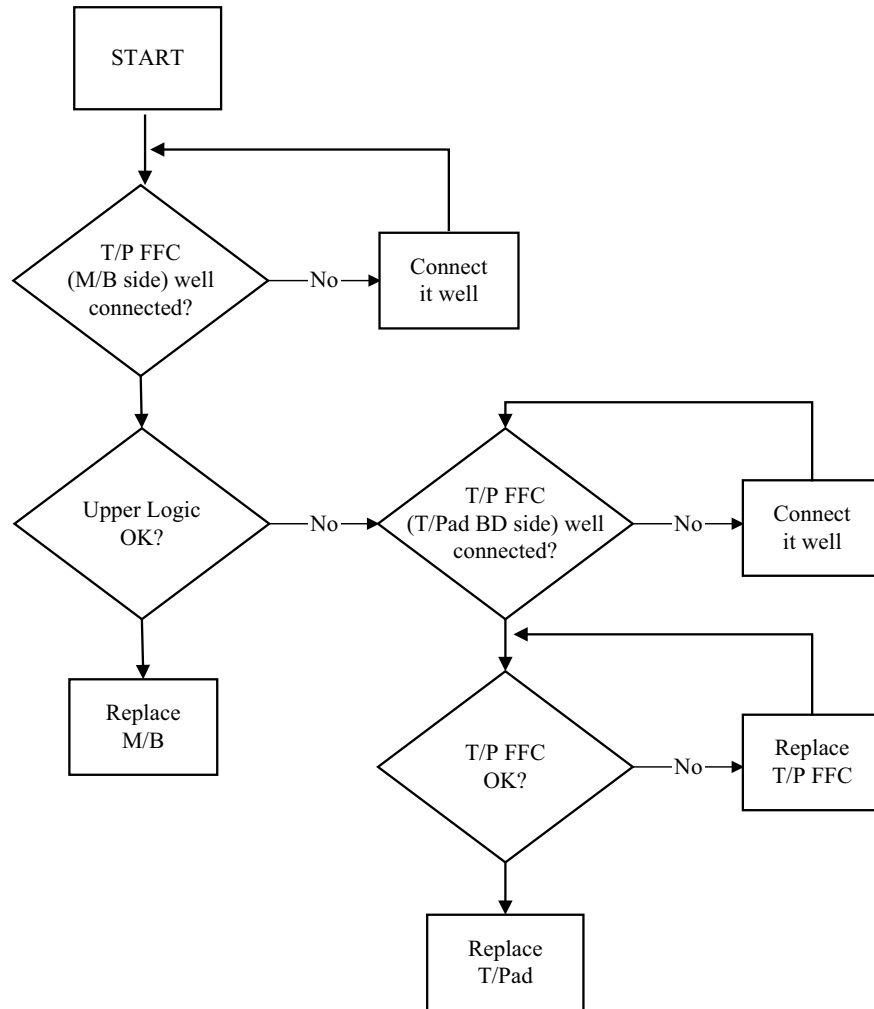



## Speaker Failure

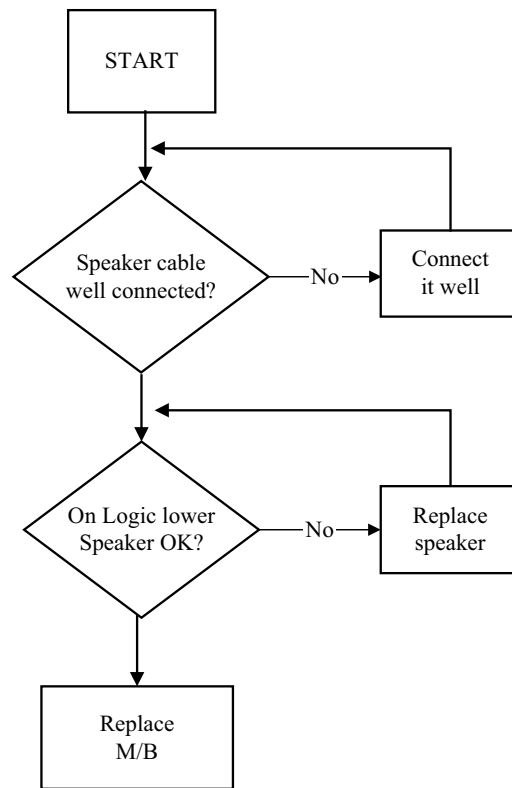

# Microphone Record Failure

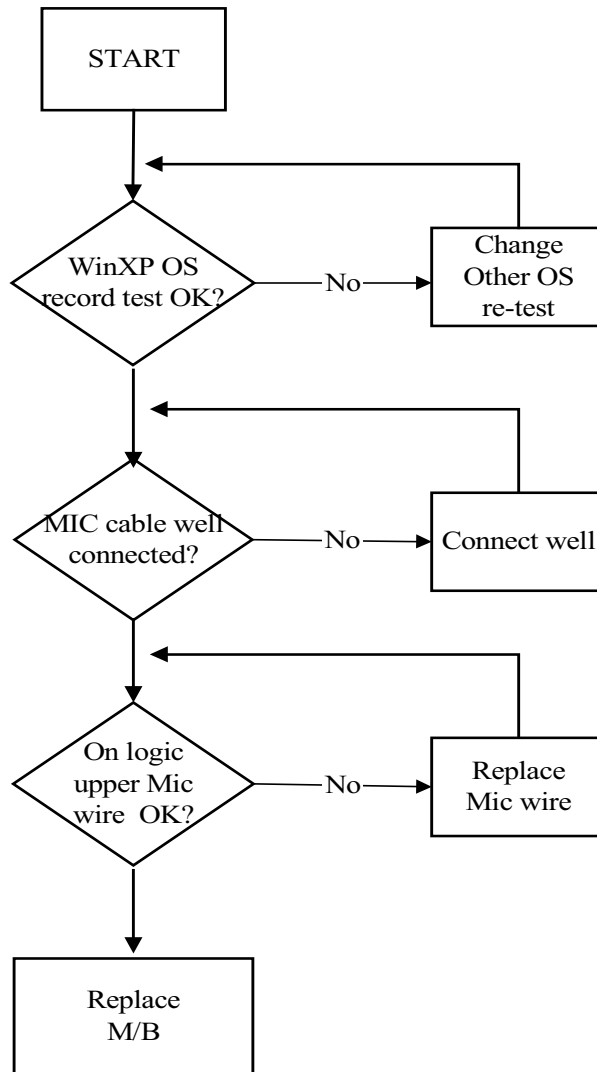

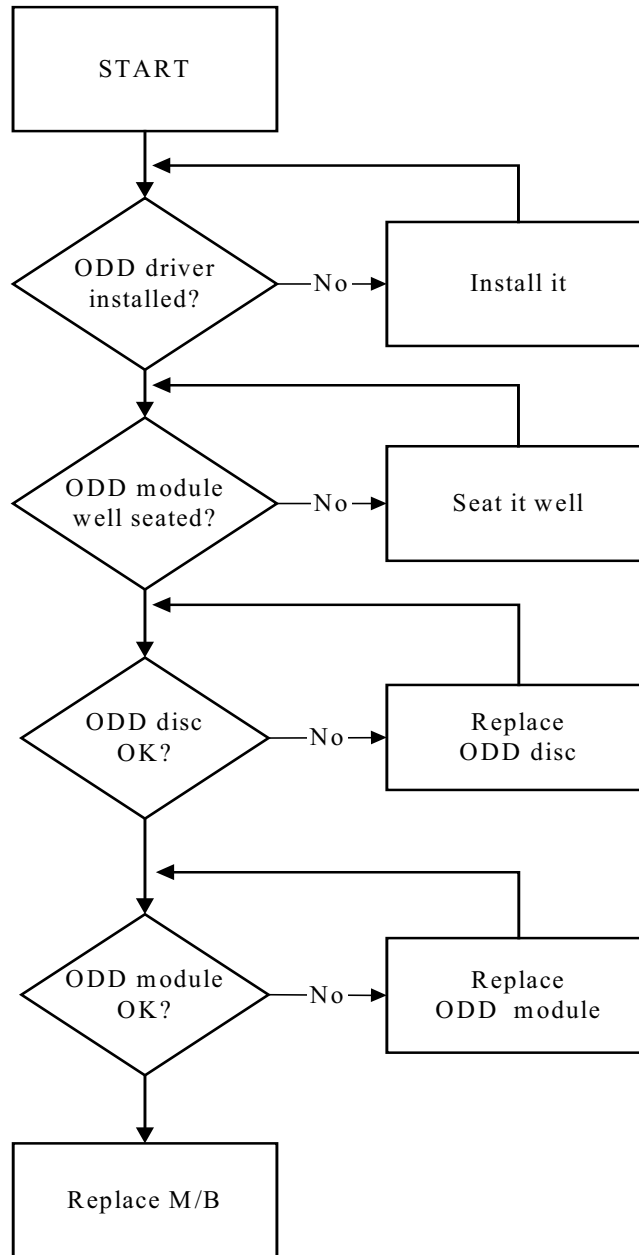

---

## ***Fir Failure***

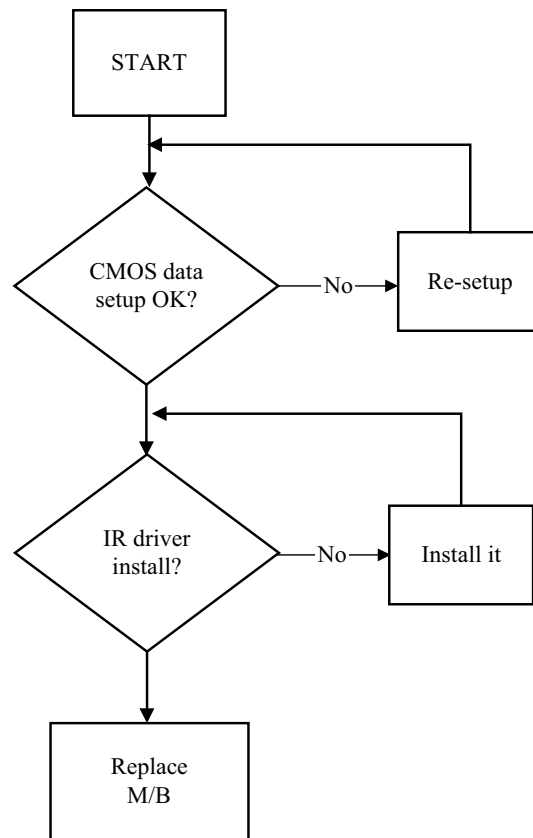

---

## PCMCIA Failure

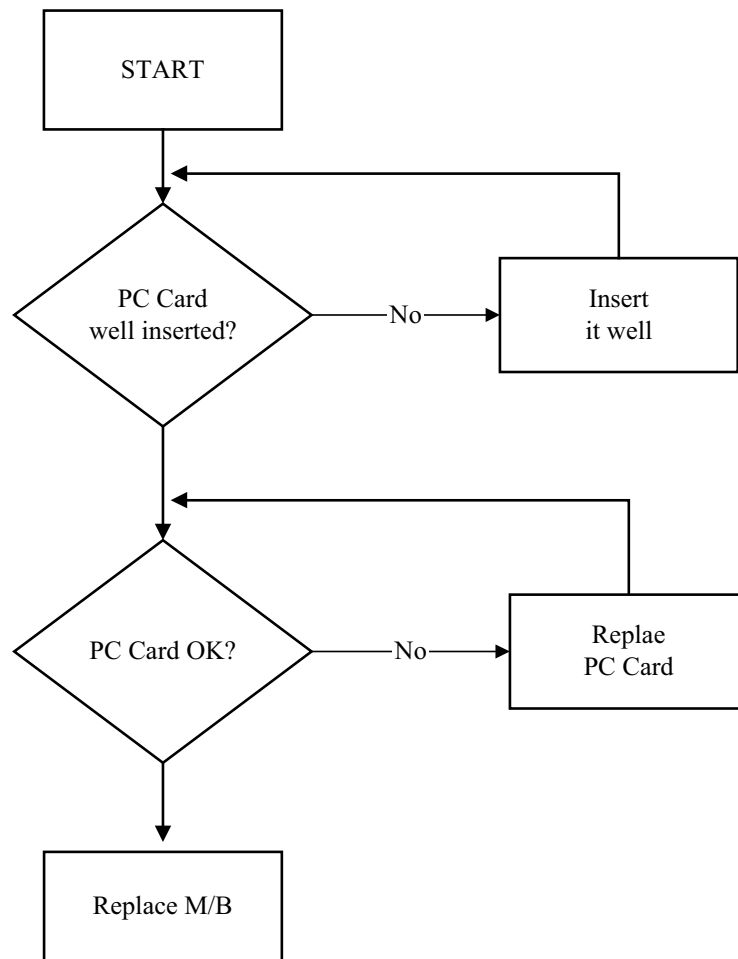

**USB Failure**

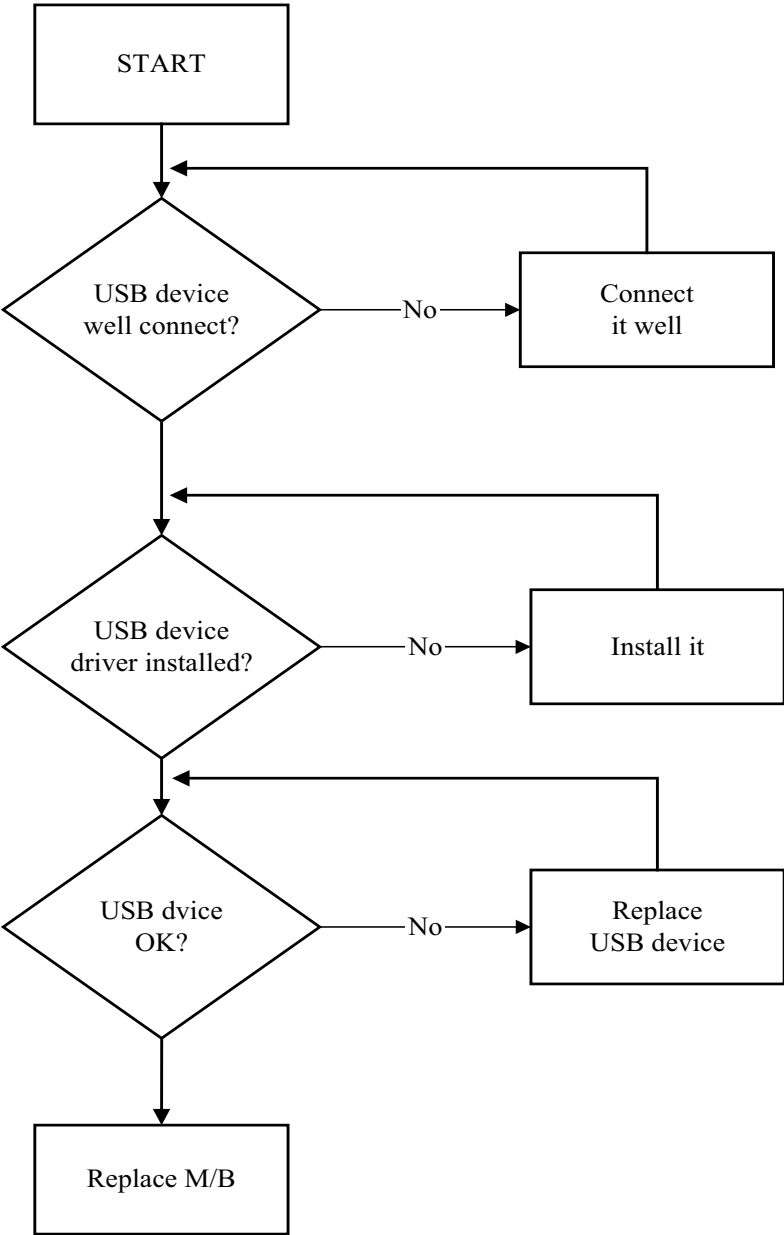

## Battery Charge Failure

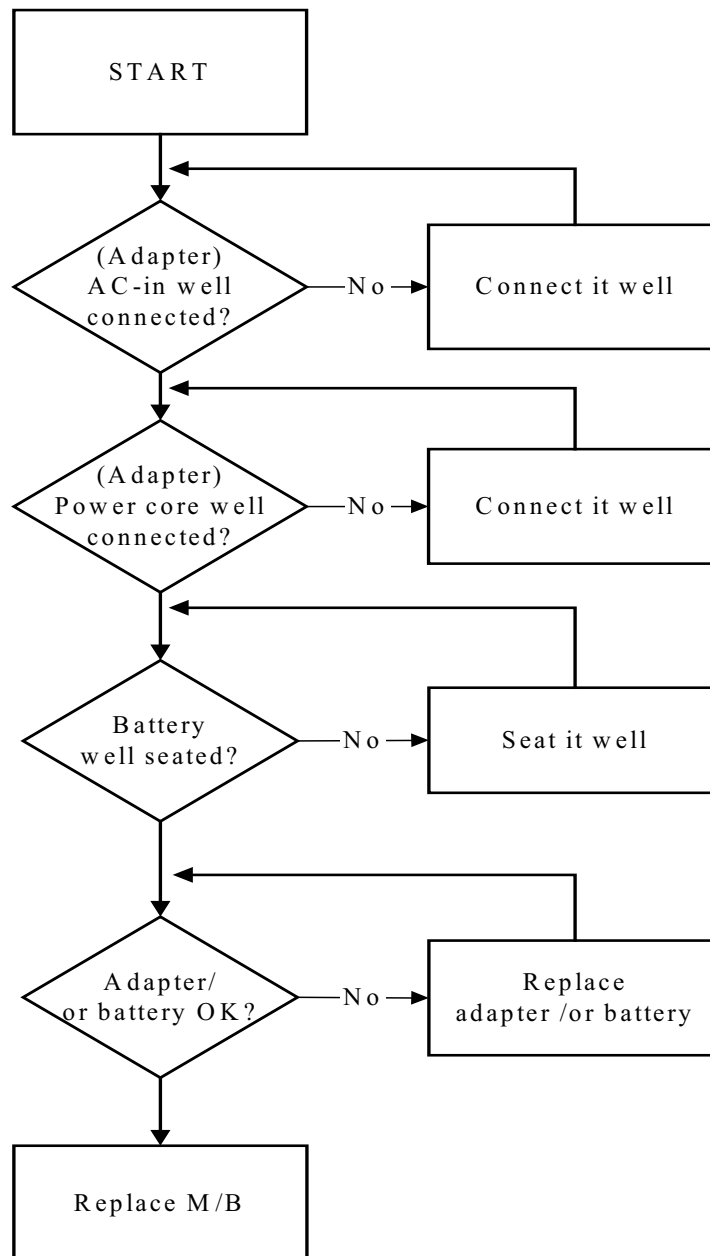

**Unit Thermal Failure**

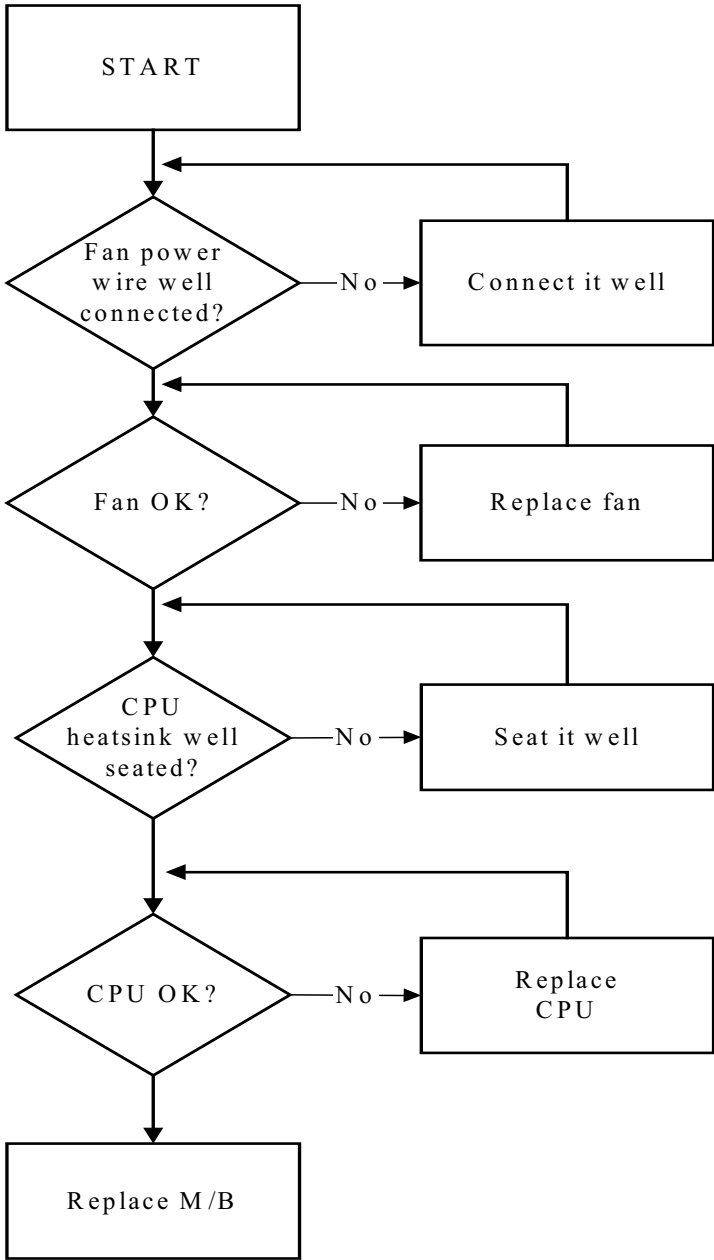



---

## Noisy HDD

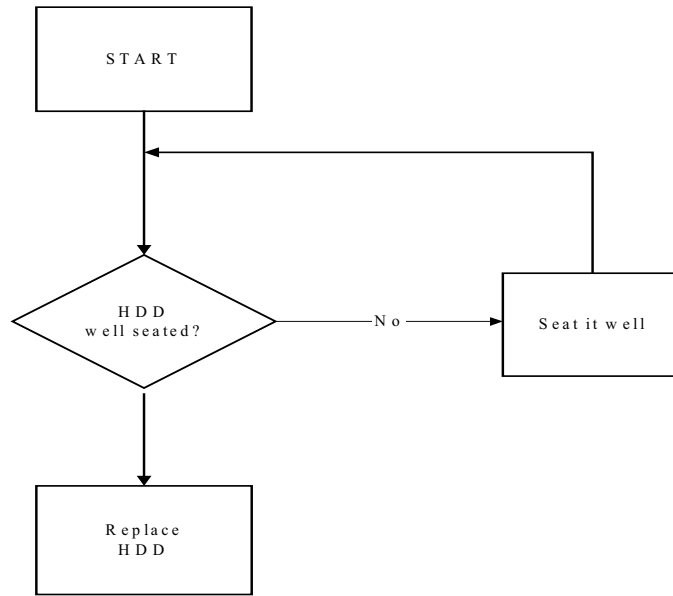

---

## LAN Function Failure

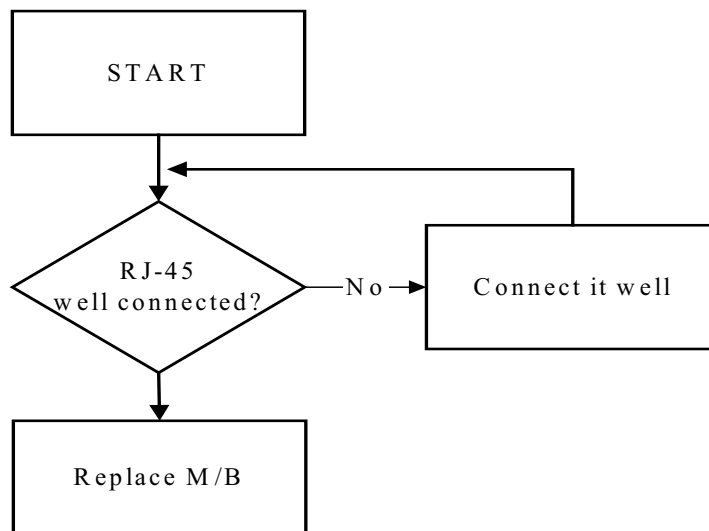

## Modem Function Failure

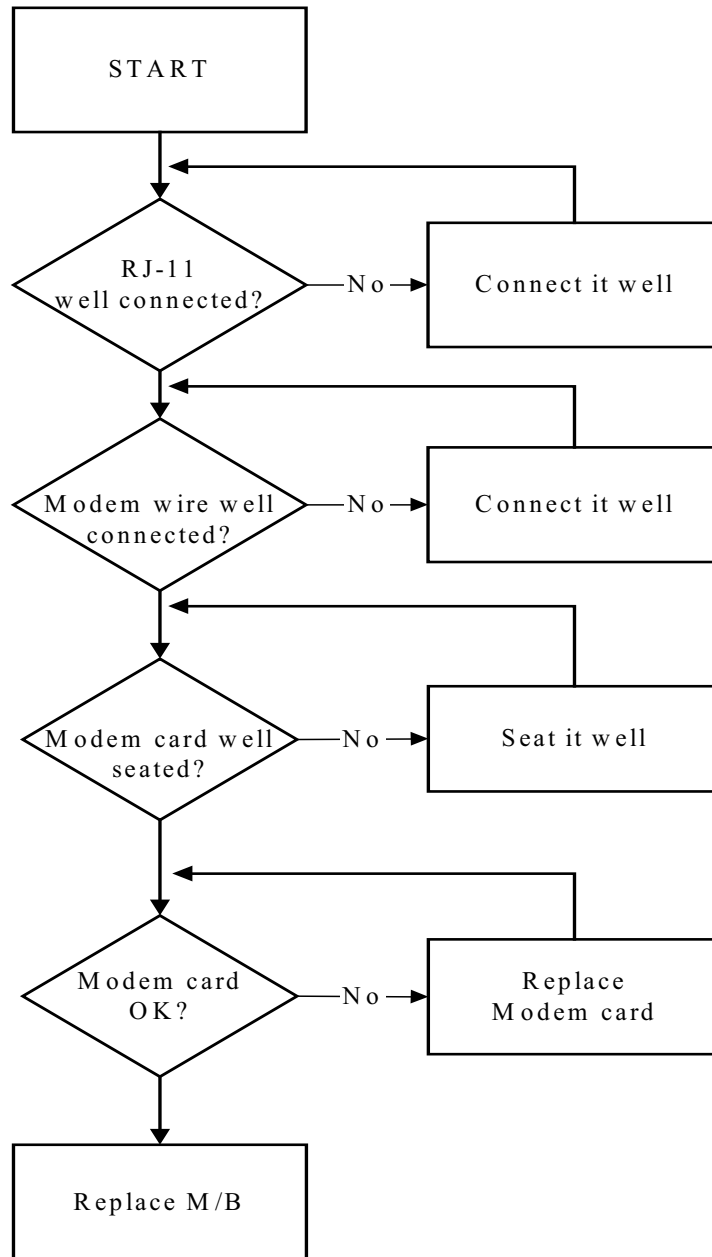

**WLAN Function Failure**

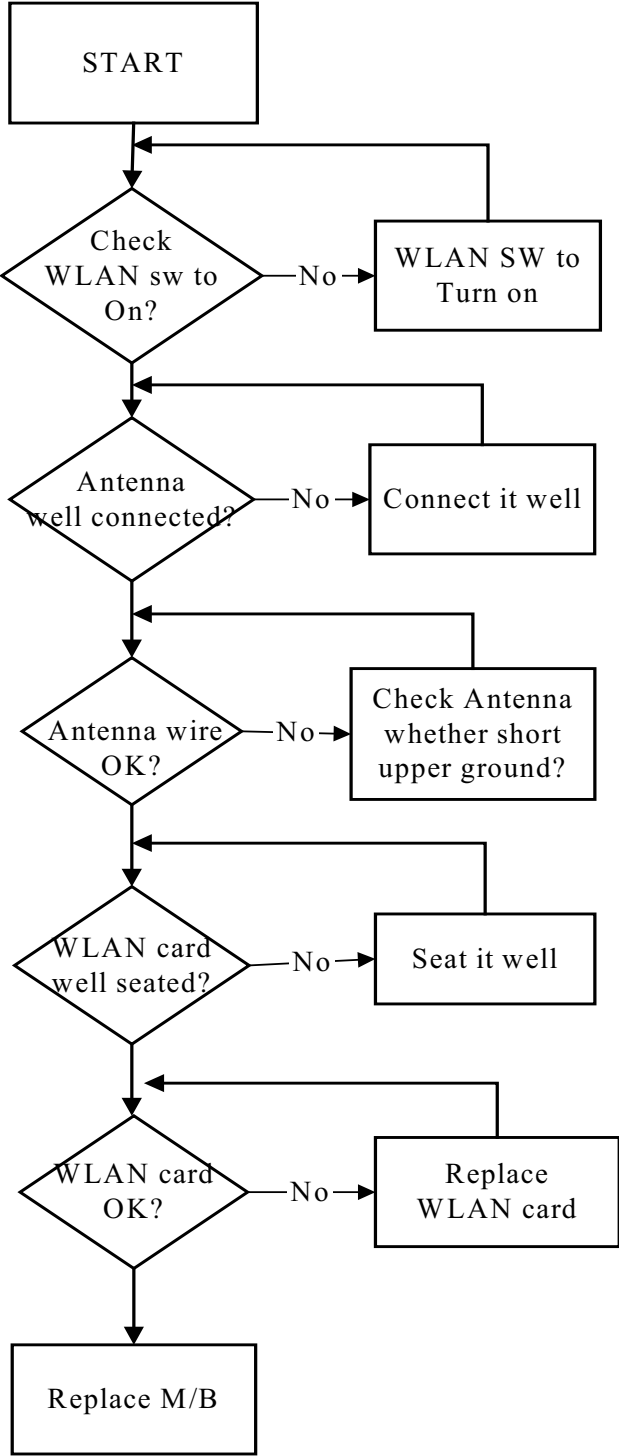

---

## Card Reader Function Failure

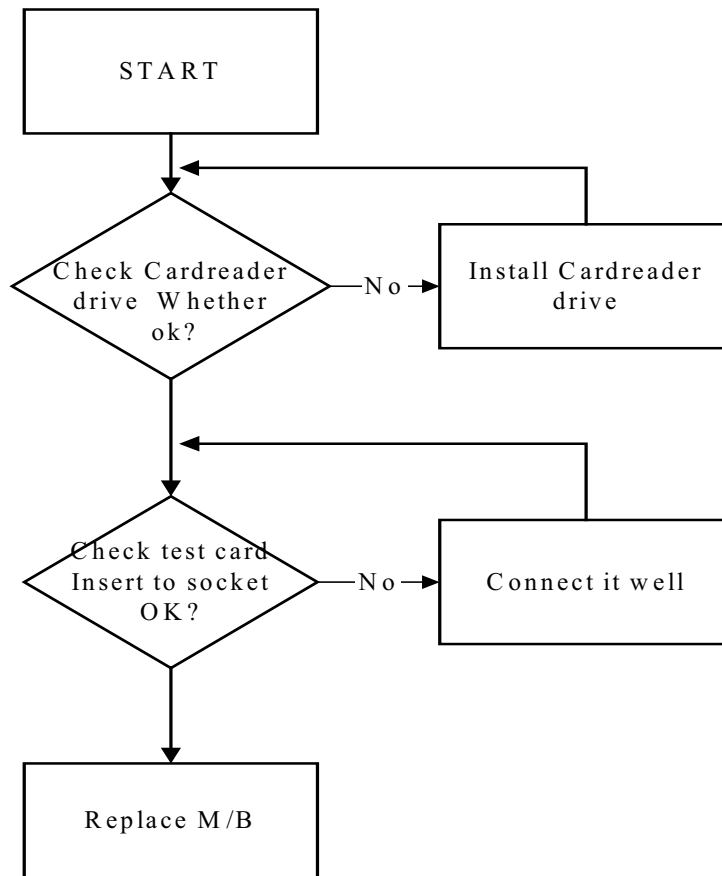

## Bridge Battery Failure

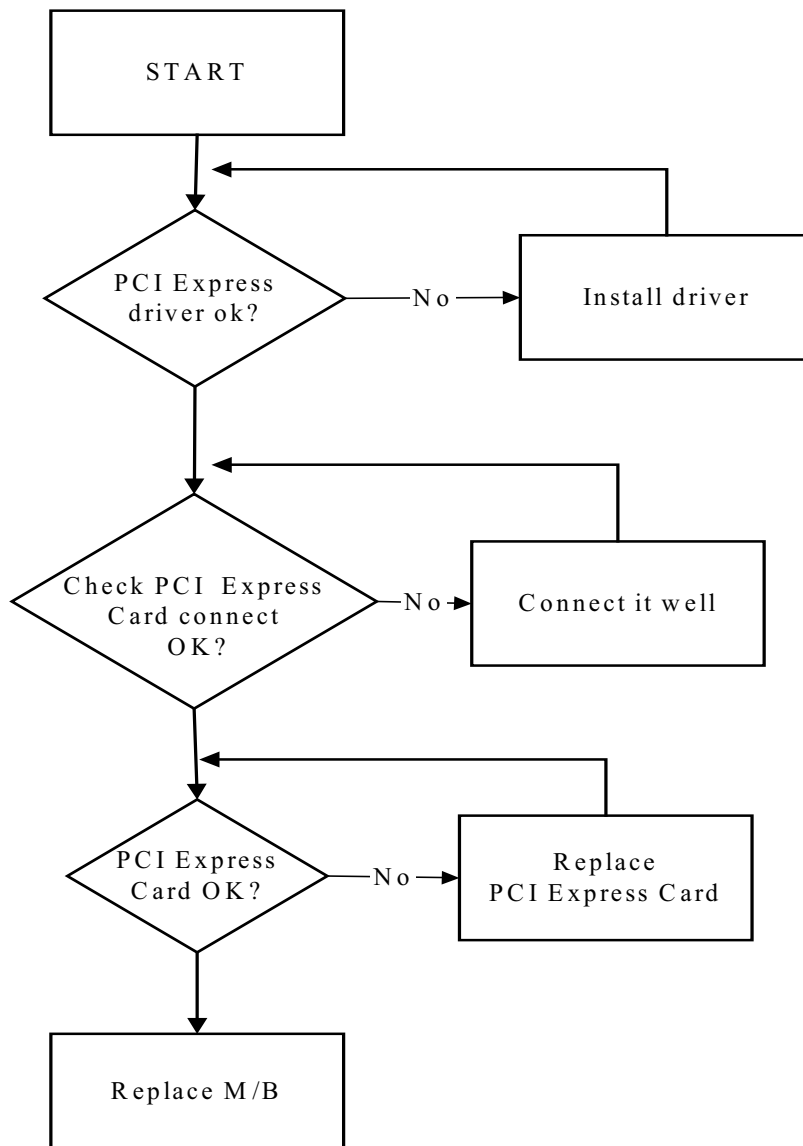

# TV-OUT Failure

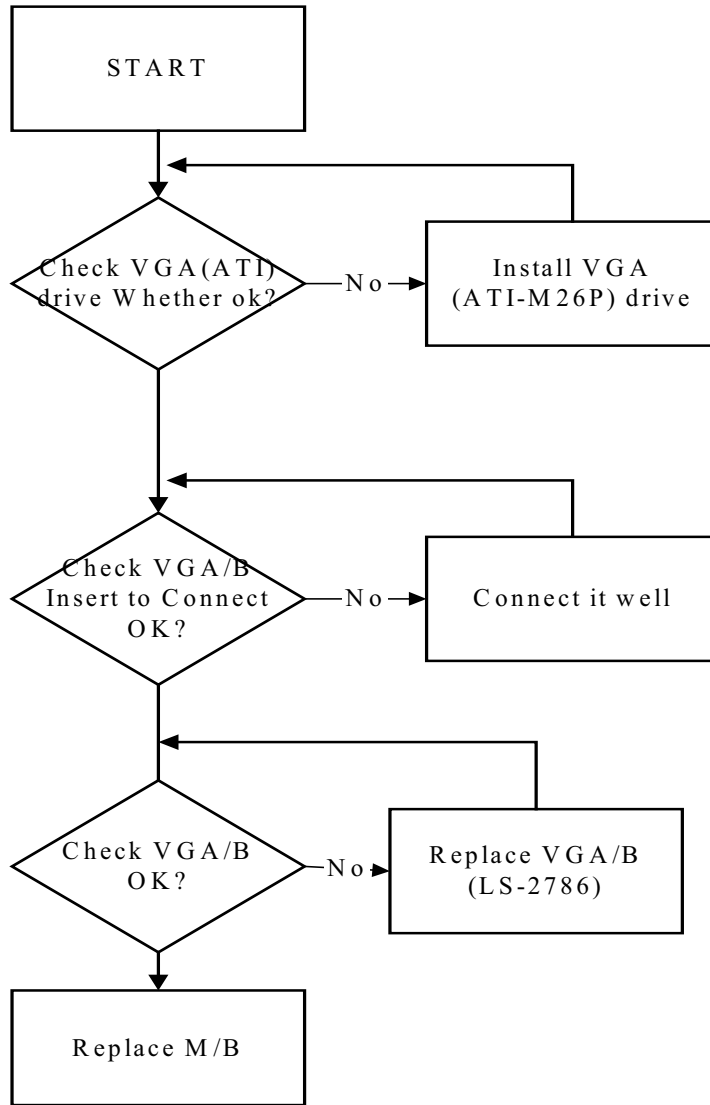

# System LED Failure

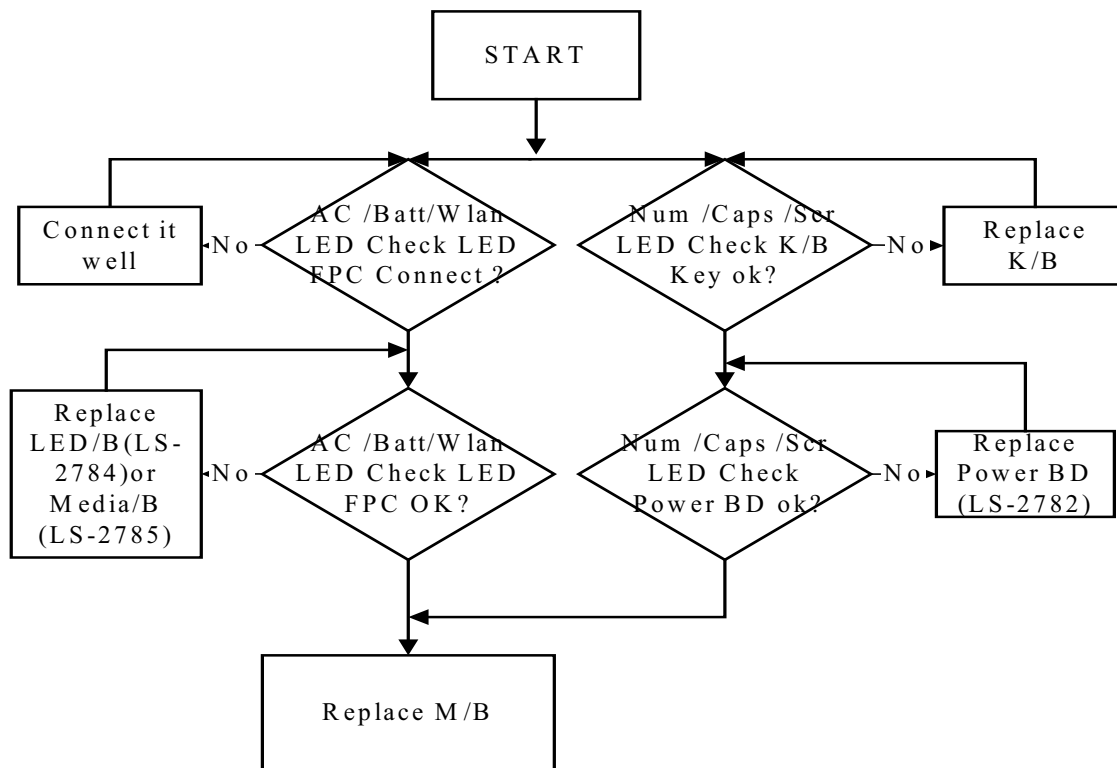



## Easy Button Failure

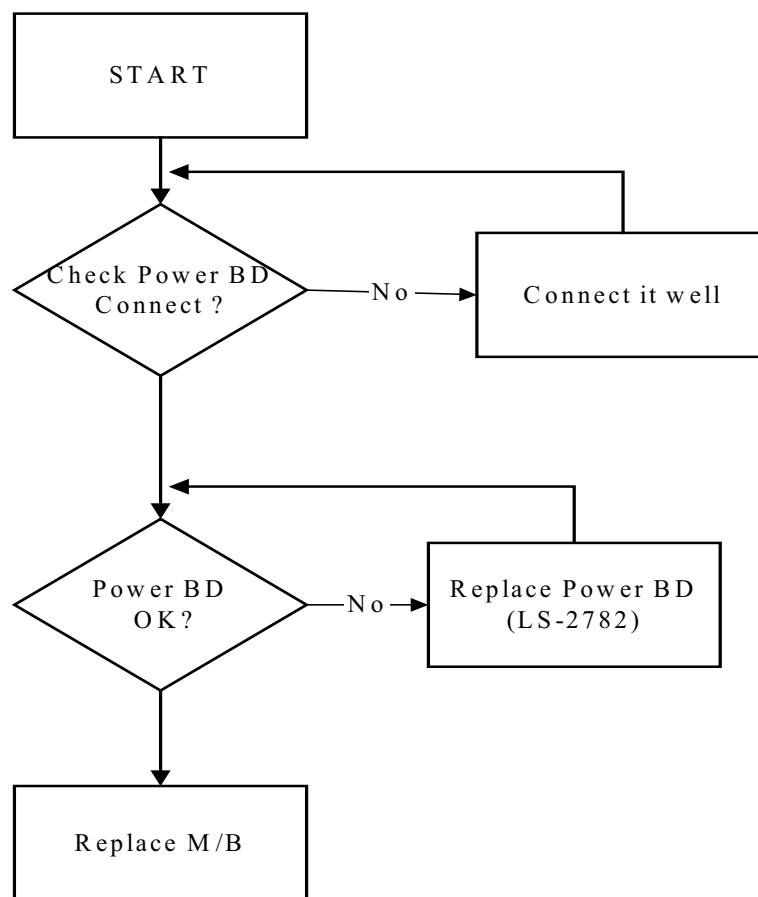

# TV Turner Function Failure

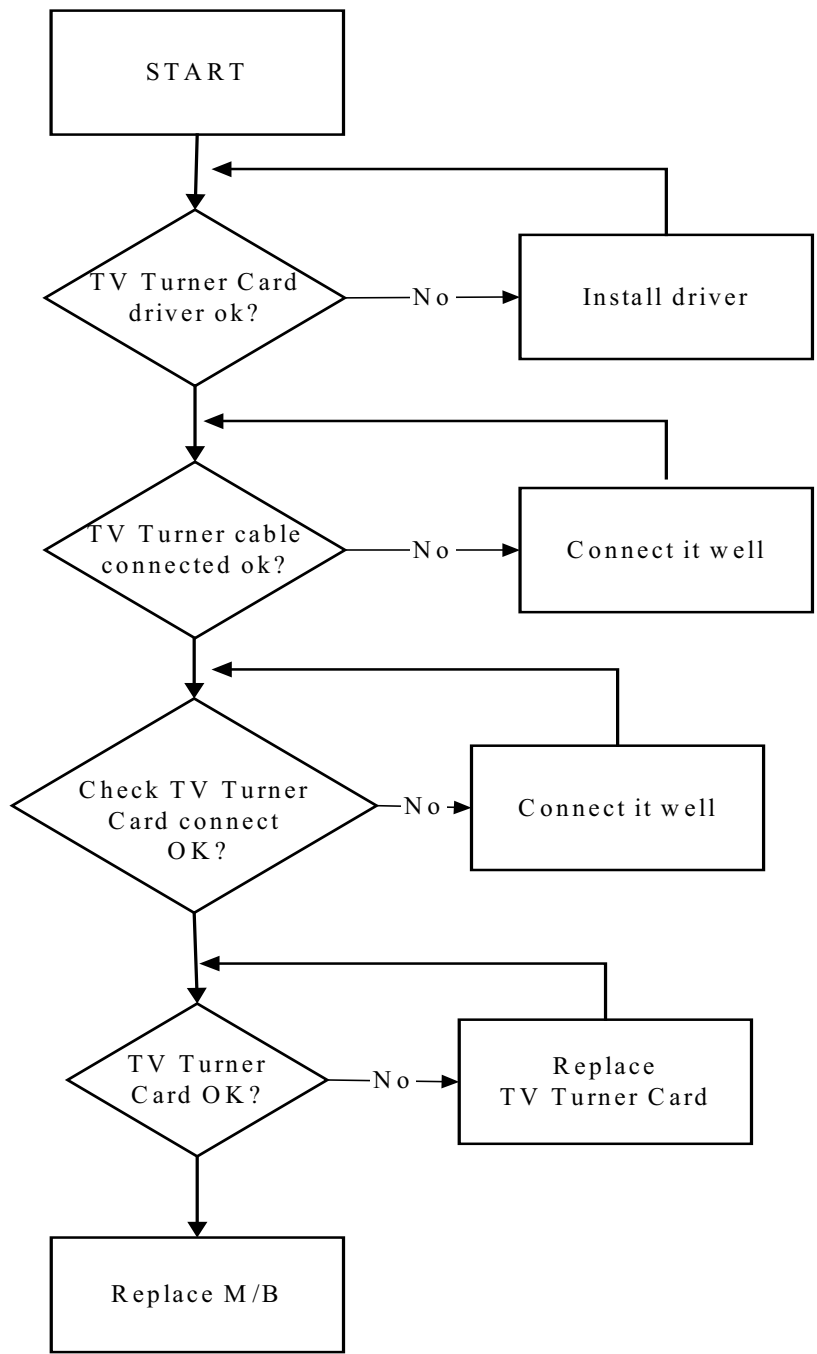

## ***FRU (Field Replaceable Unit) List***

---

Please note that WHEN ORDERING FRU PARTS, you should check the most up-to-date information available on your regional web or channel. For whatever reasons a part number change is made, it will not be noted on the printed Service Guide. For ACER AUTHORIZED SERVICE PROVIDERS, your Acer office may have a DIFFERENT part number code from those given in the FRU list of this printed Service Guide. You MUST use the local FRU list provided by your regional Acer office to order FRU parts for repair and service of customer machines.

**NOTE:** To scrap or to return the defective parts, you should follow the local government ordinance or regulations on how to dispose it properly, or follow the rules set by your regional Acer office on how to return it.

Please access to this website to obtain the latest and detail parts information

<http://aicsl.acer.com.tw/spl/>

# Exploded Diagram

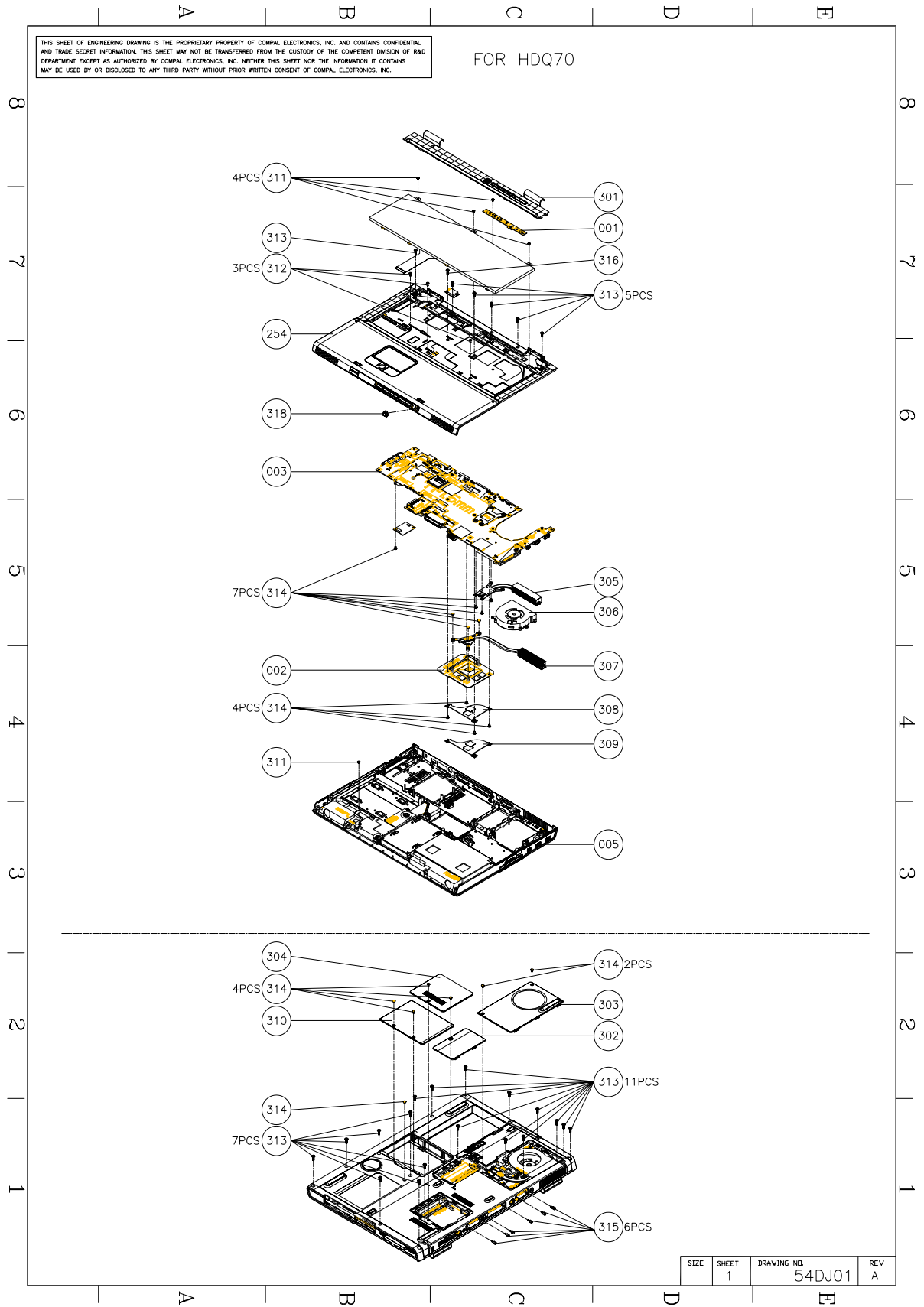

Item	Description
301	APZJY000200 HDQ70_STRIP COVER ASSY
302	APZJY000700 HDQ70 RAM DOOR ASSY
303	APZJY000900 HDQ70 THERMAL DOOR ASSY
304	APZJY000A00 HDQ70 MIN DOOR ASSY
305	ATZJY000100 HDQ70 CPU THERMAL ASSY
306	ATZJY000200 HDQ70 FAN ASSY
307	ATZJY000300 HDQ70 VGA THERMAL ASSY
308	ATZJY000400 HDQ70 NB THM ASSY
309	ATZJY000500 HDQ70 UMA NB THML ASSY
310	FAZJY000N00 LOGIC LOW HDD DOOR
311	MAAA0015320 SCREW M2.0X0.4P+3FP-ZK(NL)
312	MAC925006Z0 SCREW M2.5_9_5.5*0.8_06_R00
313	MACK25001Z0 SCREW M2.5x0.45P+12FP-ZK (NL)
314	MACK25040Z0 SCREW M2.5K 5.2X0.85 4 (NL) R00
315	MAFA94001N0 SCERW 4.75X9.6 NI
316	MMCK25150Z0 SCREW M2.5 K 15X0.45NL
317	ELZKD000J00 EFL50 VGA MYLAR
318	FAZJY000900 HDQ70 SLIDER SWITCH BTN

# LCD Exploded Diagram

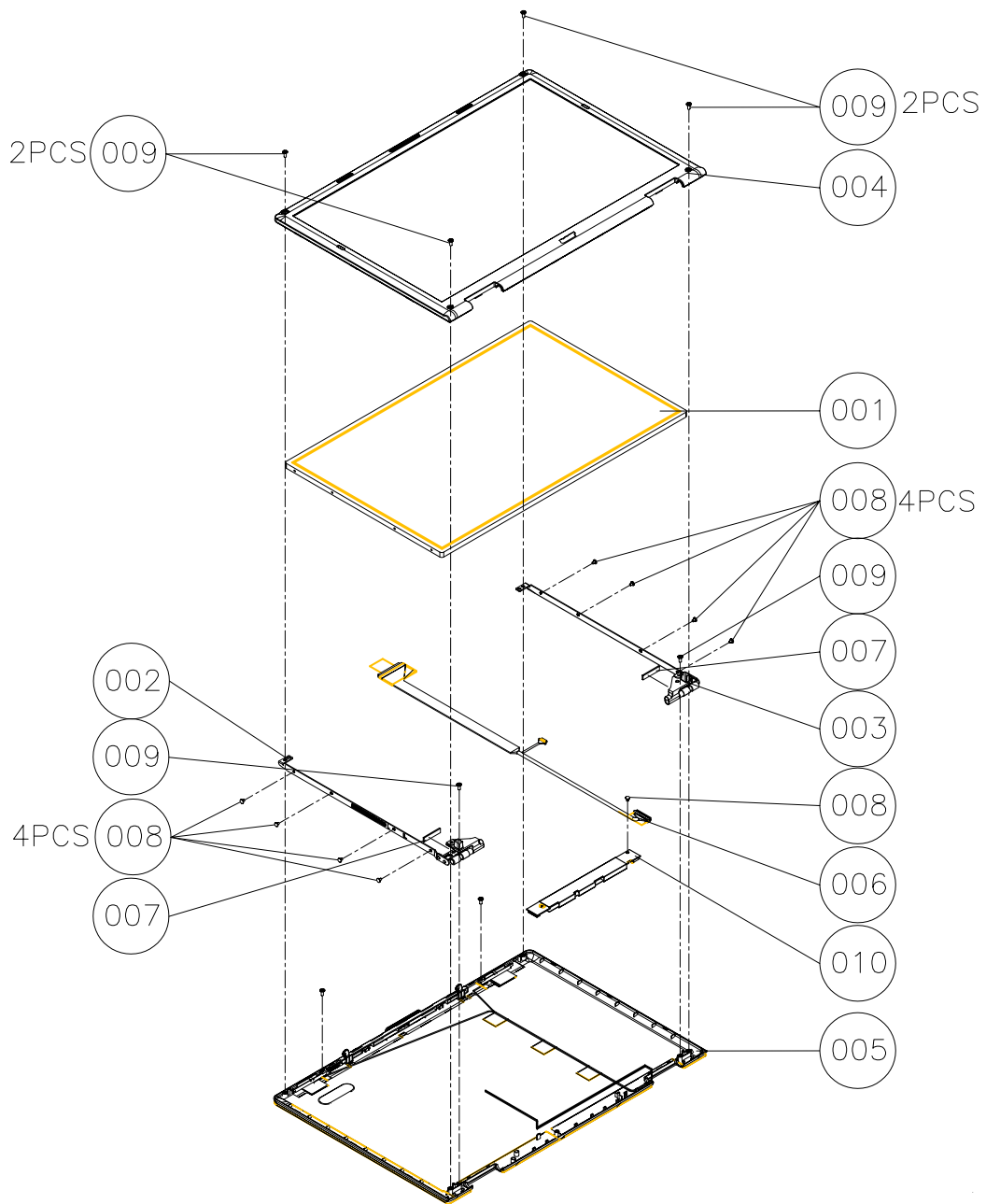

Item	Description
001	AC60000B040 LCD MODU LTN 17WP-L02-0 17" WSXGA +G
001	AC60000BE00 LCD MODU LP171WP-5-TL03 17" WXGA GLARE
002	AMZJY000300 HDQ70 HINGE BRK L LGWX2 ASSY
002	AMZJY000500 HDQ70 HINGE BRK L LGWP5 ASSY
003	AMZJY000400 HDQ70 HINGE BRK R LGWX2 ASSY
003	AMZJY000600 HDQ70 HINGE BRK R LGWP5 ASSY

Item	Description
004	APZJY000300 HDQ70 LCD BEZEL ASSY ASM
005	APZJY000400 HDQ70 LCD COVER ASSY ASM
005	APZJY000500 HDQ70 LCD COVER 2 ASSY ASM
006	DC020004S00 H CONN SET ZJY MB LCD
006	DC020004Y00 H CONN ZJY MB LCD DUAL TUBE
007	FHZYV000200 ECQ60 LCD PANEL RUBBER PRT
008	MAAA0015320 SCREW M2.0 X0.4+3FP-ZK(NL)
009	MAC925006Z0 SCREW M2.5_9_5.5*0.8_06_R00
010	PK070005L00 INVERTER ZJY 17" DUAL LAMPS DAC 09N011
010	PK070005M00 INVERTER ZJY 17" DUAL LAMPS YNV-C11 YEC
010	PK070015700 INVERTER BTQ00 17.1" TWS-442-150 SUMIDA
010	PK070018200 INVERTER EEW00 17" DAC 09B029 DELTA MPS
010	PK070018300 INVERTER CQ60 17" TWS-442+176 SUMIDA
010	PK070018600 INVERTER EEQ00 17" YNV-C03A YEC MPS

## HDD Exploded Diagram

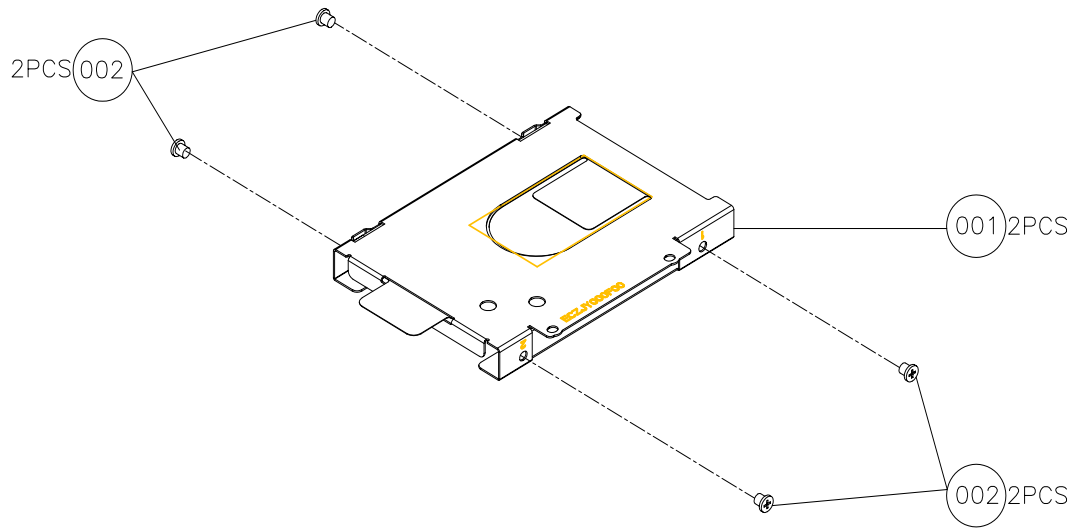

Item	Description	No.
001	AMZJY000700 HQ70_HDD_CARRIER_PLATE_ASSY	1
002	MAAA0004308 SCREW M3X0.5+4FR- ZK(H5.2*T0.8)	4



# ODD Exploded Diagram

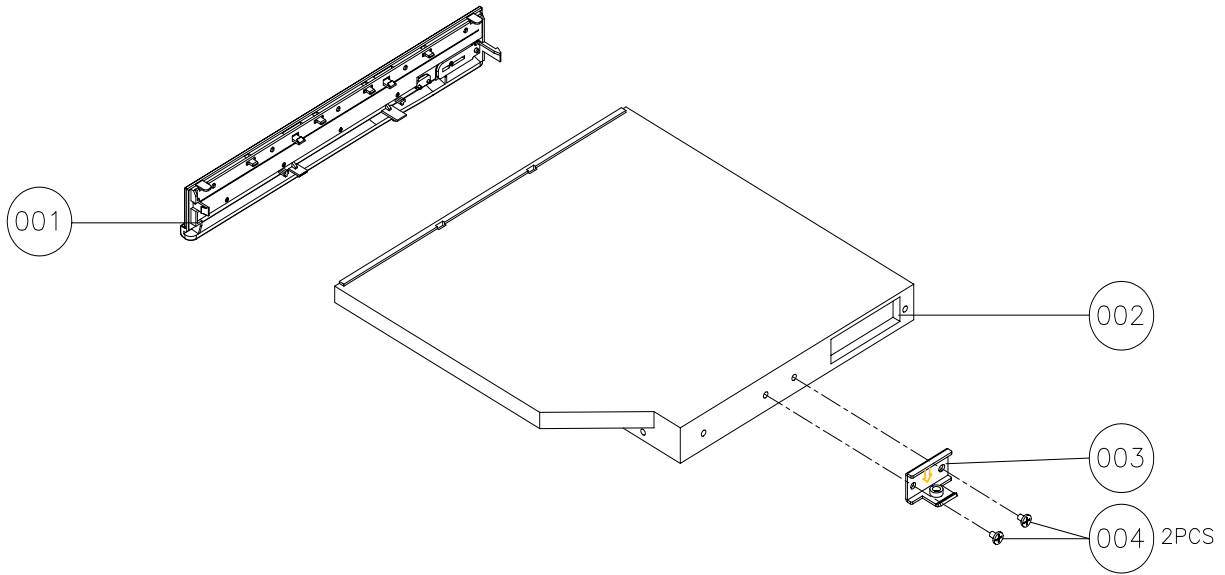

## DVD Dual Exploded Diagram

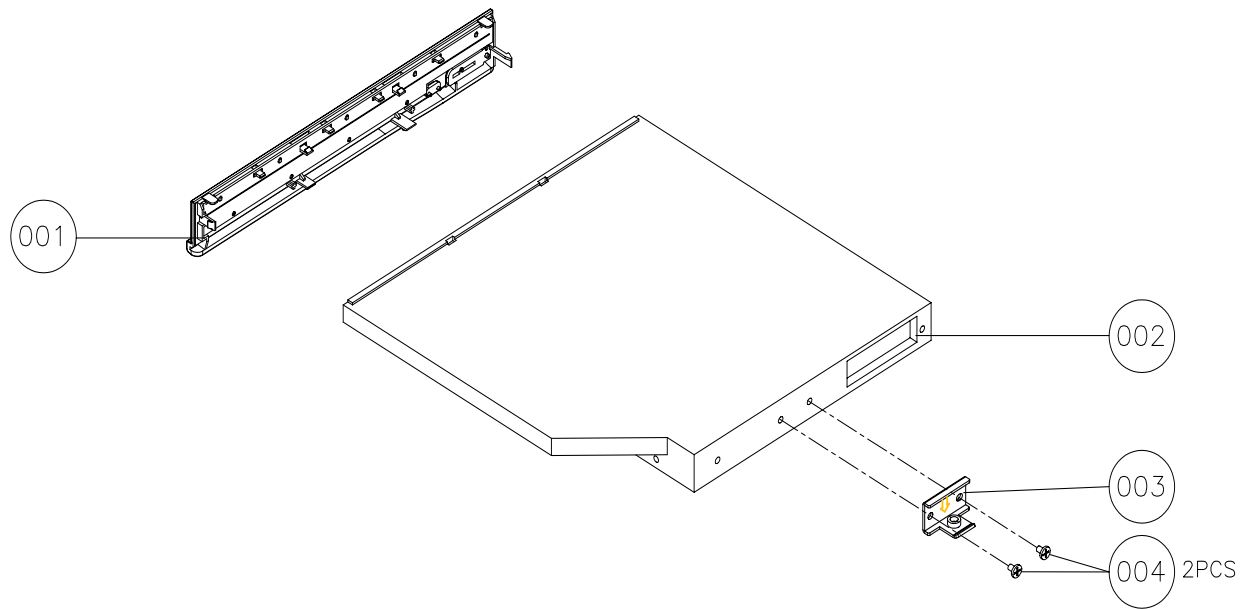

Item	Description
001	APZJY000800 K/B PACK DARFON EMW80 PO REV00 ABO
001	APZJY000C00 HDQ70 ODD MKE PANEL ASSY
002	DD600001N40 DVDRW DRV 8X 650/4.7 5"H DVR-K05RA 030
002	DDR60005210 DVDRW DRV 8X 650/4.7 5"H UJ-845 030
003	ECZJY000K00 HDQ70 ODD SUP PLATE
004	MAAA0015320 SCREW M2.0X0.4P+3FP-ZK(NL)

## Upper Case Exploded Diagram

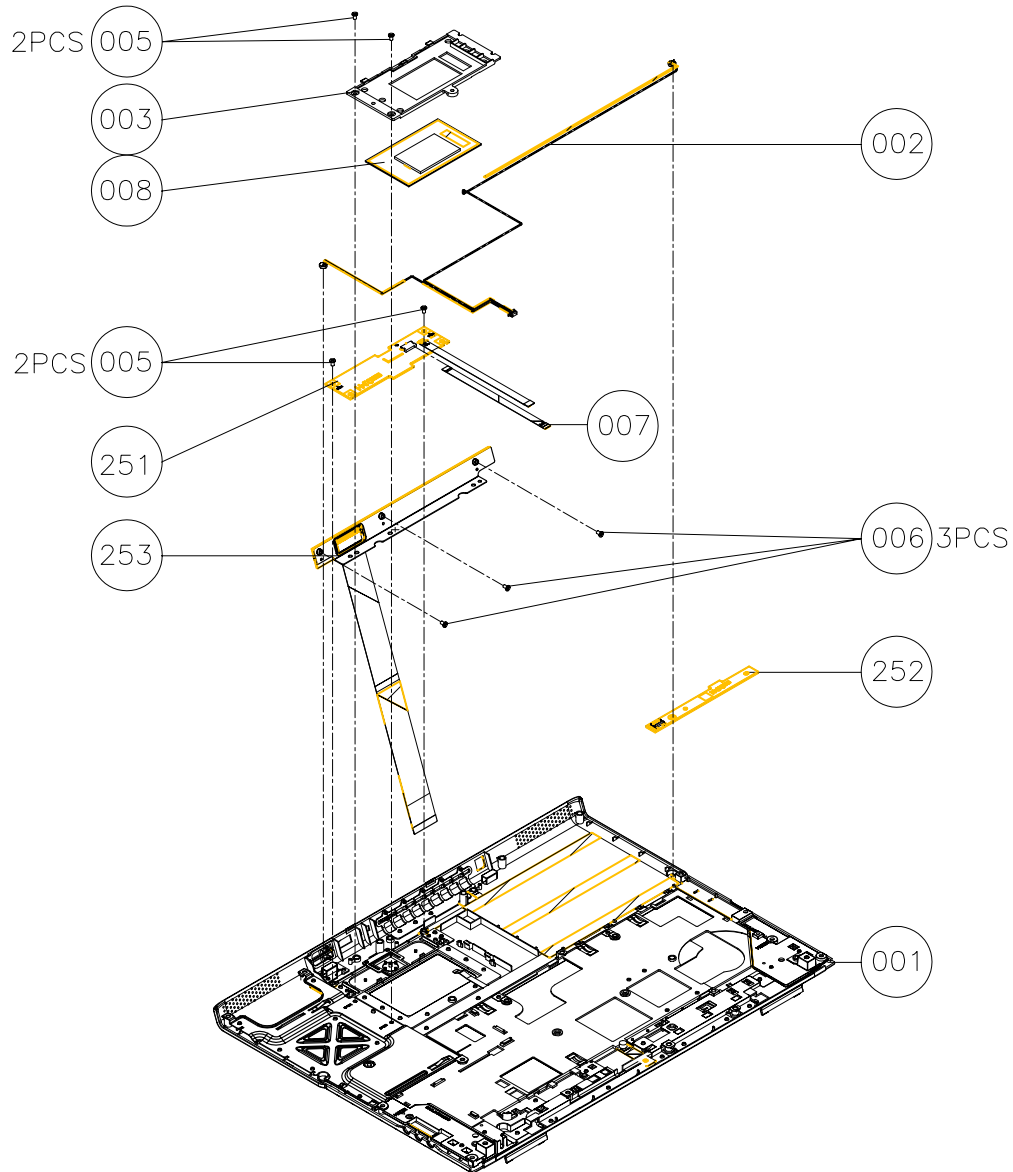

Item	Description
001	APZJY000100 HDQ70 LOG UP SUB ASSY
001	APZJY000110 HDQ70 LOG UP SUB ASSY UMA
002	DC020004X00 H CONN SET ZJY MB-MIC
003	FAZJY000E00 HDQ70 TP SUP PLATE
005	MAAA0015320 SCREW M2.0X0.4P+3FP-ZK
006	MACK25040Z0 SCREW M2.5 K 5.2X0.85 4
007	NBX00001D00 FFC 12P F P.5 PAD-0.35 1133MM TP/B-TP ZJY
008	PK090006610 TRACK PAD SYNAPTICS TM61PUF1G372
251	455907B0001 PCBA TP/B LS-2783 HDQ70
252	455908B0001 LED/B LS-2784 HDQ70
253	455914B0001 PCBA MEDIA /B LS-2785 HDQ70



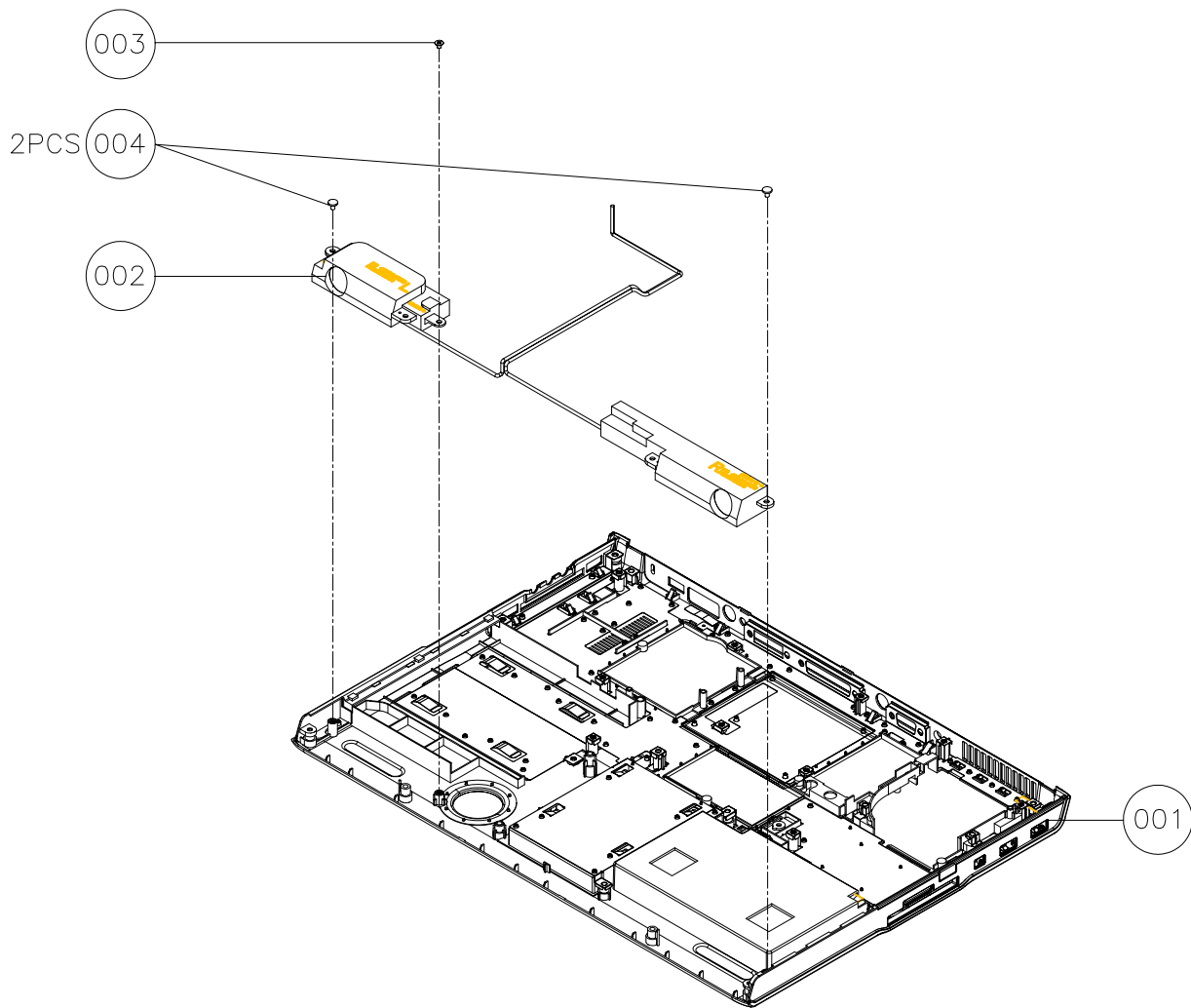

## Lower Case Exploded Diagram

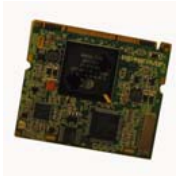

Item	Description
001	APZJY000600 HDQ70 LOGIC LOWER SUB ASSY
001	APZJY000B00 HDQ70 LOGIC LOW SUB ASSY UMA
002	PK230003000 SPK PACK ZJY 2W 3 OHM
002	PK230003P00 SPK PACK ZJY 3W 4 OHM WOOFER
002	PK230003R00 SPK PACK ZJY 2W 4 OHM MAIN
003	MAAA0015320 SCREW M2.0X0.4P+3FP-ZK
004	MACK25040Z0 SCREW M2.5 K 5.2X0.85 4 NL

## Aspire 9500 Parts

Illustration	DESCRIPTION	Acer P/N
<b>ADAPTER</b>		
	ADAPTER 90W 3PIN DELTA ADP-90SB BBAC	AP.09001.003
	ADAPTER 90W 3PIN LITEON PA-1900-04AC	AP.09003.003
<b>BATTERY</b>		
	BATTERY LI-ION 8 CELLS 4.3AH SANYO	BT.00803.005
	BATTERY LI-ION 8 CELLS 4.3AH SONY	BT.00804.004
<b>BOARD</b>		
	MODEM BOARD (FOXCONN T60M845.02)	54.A61V5.001
	BLUETOOTH MODULE W/ANTENNA	54.A61V5.002
	MINI PCI WIRELESS BOARD 802.11B/G FOXCONN	54.A61V5.003
	MINI PCI WIRELESS BOARD 802.11B/G MOW INTEL WM3B2200	KI.CAX01.008
	MINI PCI WIRELESS BOARD 802.11B/G ROW INTEL WM3B2200	KI.CAX01.013
	POWER BOARD	55.A61V5.001
	TP BOARD W/FFC	55.A61V5.002
	LED BOARD - UMA	55.A63V5.001
	MEDIA CONSOLE BOARD W/FFC - DISCRETE	55.A61V5.003







Illustration	DESCRIPTION	Acer P/N
	TV TUNER - M104 ANALOG	55.A61V5.004
	TV TUNER - M115 ANALOG + DTV	55.A61V5.005
	VGA CARD - M26P128MB	55.A62V5.001
	VGA CARD - M26P256MB	55.A61V5.006
<b>CABLE</b>		
	FFC CABLE -TP BOARD TO TP	50.A61V5.001
	MDC CABLE	50.A61V5.002
	BLUETOOTH CABLE	50.A61V5.003
	TV TUNER CABLE	50.A61V5.004
	POWER CORD AUS 3PIN	27.A61V5.001
	POWER CORD CHINA 3PIN	27.A61V5.002
	POWER CORD DENMARK 3PIN	27.A61V5.003
	POWER CORD EU 3PIN	27.A61V5.004
	POWER CORD ITALY 3PIN	27.A61V5.005
	POWER CORD KOREA 3PIN	27.A61V5.006
	POWER CORD SOUTH AFRICA 3PIN	27.A61V5.007
	POWER CORD SWISS 3PIN	27.A61V5.008
	POWER CORD UK 3PIN	27.A61V5.009
	POWER CORD US 3PIN	27.A61V5.010
	POWER CORD US BSMI 3PIN	27.A61V5.011
<b>CASE/COVER/BRACKET ASSEMBLY</b>		
	MIDDLE COVER	42.A61V5.001







	LOWER CASE W/O DVI PORT- UMA	60.A63V5.001
	UPPER CASE W/MIC, MEDIA CONSOLE LABEL - UMA	60.A63V5.002
	LOWER CASE - DISCRETE	60.A61V5.001
	UPPER CASE W/MIC - DISCRETE	60.A61V5.002
	THERMAL DOOR W/RUBBER FOOT	42.A61V5.002
	RAM DOOR	42.A61V5.003
	MINI PCI DOOR	42.A61V5.004
	5-WAY BUTTON	42.A61V5.005
	MEDIA BOARD SUPPORT BRACKET	33.A61V5.001
	TP SUPPORT PLATE	33.A61V5.002
	DUMMY NEW CARD	42.A61V5.010

	NEW CARD CASE	42.A61V5.011
	HDD DOOR	42.A61V5.009
	HDD CARRIER	33.A61V5.004
<b>COMMUNICATION MODULE</b>		
	WIRELESS ANTENNA ASSY	50.A61V5.005
<b>CPU/PROCESSOR</b>		
	INTEL PENTIUM M 1.6G 2M Tj85 400FSB uFCPGA2 SL89T C-0 STEPPING	KC.N0001.725
	INTEL PENTIUM M 1.6G 2M 533FSB uFCPGA2 SL86G C-1 STEPPING	KC.N0001.730
	INTEL PENTIUM M 1.73G 2M 533FSB uFCPGA2 SL7SA C-1 STEPPING	KC.N0001.740
	INTEL PENTIUM M 1.87G 2M 533FSB uFCPGA2 SL7S9 C-1 STEPPING	KC.N0001.750
	INTEL PENTIUM M 2.0G 2M 533FSB uFCPGA2 SL7SM C-1 STEPPING	KC.N0001.760
	INTEL PENTIUM M 2.13G 2M 533FSB uFCPGA2 SL7SL C-1 STEPPING	KC.N0001.770
<b>COMBO DRIVE</b>		
	DVD/CDRW COMBO MODULE PAN UJDA-770 TRAY IN	6M.A61V5.001
	DVD/CDRW COMBO MODULE PAN CW-8124 SLOT IN	6M.A61V5.002
	DVD/CDRW COMBO DRIVE PANASONIC UJDA-770	KO.02406.013
	DVD/CDRW COMBO DRIVE PANASONIC CS-8124 SLOT IN	KO.02406.015
	DVD DUAL MODULE DL PAN UJ-845-CAA SLOT IN	6M.A61V5.003
	DVD DUAL DRIVE PANASONIC UJ-845 DL SLOT IN	KU.00807.015
	DVD DUAL MODULE DL PIONEER DVR-K05RA SLOT IN	6M.A61V5.004
	DVD DUAL DRIVE PIONEER DVR-K05RA SLOT IN	KU.00805.013
<b>HDD/HARD DISK DRIVE</b>		







	HDD 60GB 2.5IN. 4200RPM HGST MORAGA IC25N060ATMR04-0 08K0634 F/S:AD4A	KH.06007.006
	HDD 60GB 2.5IN. 4200RPM TOSHIBA PLUTO MK6025GAS(ROHS) F/W KA200A	KH.06004.004
	HDD 60GB 2.5IN. 4200RPM SEAGATE N2 ST960821A F/W 3.01	KH.06001.002
	HDD 80GB 2.5IN. 4200RPM HGST MORAGA IC25N080ATMR04-0 08K635 FW:AD4A	KH.08007.007
	HDD 80GB 2.5IN. 4200RPM TOSHIBA PLUTO MK8025GAS F/W KA023	KH.08004.003
	HDD 80GB 2.5IN. 4200RPM SEAGATE N2 ST9808210A F/W 3.01	KH.08001.012
	HDD 100GB 2.5IN. 4200RPM SEAGATE N2 ST9100822A F/W 3.01	KH.10001.001
	HDD 100GB 2.5IN. 4200RPM TOSHIBA PLUTO MK1031GAS F/W AA20	KH.10004.001
	HDD 100GB 2.5IN. 5400RPM SEGATE MERCURY ST9100823A F/W 3.01	KH.10004.002
	HDD 100GB 2.5IN. 5400RPM TOSHIBA ARES MK1032GAX F/W:AB211A ROHS	KH.10004.003
	HDD 100GB 2.5IN. 5400RPM HGST MORAGA+ HTS541010G9AT00 ROHS	KH.10004.004
	<b>KEYBOARD</b>	
	KEYBOARD SUNREX ARABIC	KB.A2909.011
	KEYBOARD SUNREX BELGIAN	KB.A2909.013
	KEYBOARD SUNREX CANADIAN FRENCH	KB.A2909.007
	KEYBOARD SUNREX TRADITIONAL CHINESE	KB.A2909.005
	KEYBOARD SUNREX CZECH	KB.A2909.015
	KEYBOARD SUNREX DENMARK	KB.A2909.018
	KEYBOARD SUNREX FRENCH	KB.A2909.006
	KEYBOARD SUNREX GERMAN	KB.A2909.003
	KEYBOARD SUNREX GREECE	KB.A2909.021
	KEYBOARD SUNREX HUNGARY	KB.A2909.016
	KEYBOARD SUNREX ITALY	KB.A2909.004
	KEYBOARD SUNREX NORWAY	KB.A2909.017
	KEYBOARD SUNREX PORTUGUESE	KB.A2909.010
	KEYBOARD SUNREX RUSSIAN	KB.A2909.019
	KEYBOARD SUNREX SPAIN	KB.A2909.009
	KEYBOARD SUNREX SWEDEN	KB.A2909.014
	KEYBOARD SUNREX SWISS/G	KB.A2909.008
	KEYBOARD SUNREX THAILAND	KB.A2909.012
KEYBOARD SUNREX TURKISH	KB.A2909.020	
KEYBOARD SUNREX UK	KB.A2909.002	
KEYBOARD SUNREX US INTERNATIONAL	KB.A2909.001	
<b>LCD MODULE</b>		

	ASSY LCD MODULE 17.1 WXGA W/GLARE LG (LP171WX2-A4K5)	6M.A61V5.012
	LCD 17.1 WXGA W/GLARE LG (LP171WX2-A4K5) GARE TYPE	LK.17108.007
	LCD INVERTER - 7.5MM	19.A61V5.001
	LCD PANEL WITH LOGO W/ANTENNA - 7.5MM	60.A61V5.003
	LCD BEZEL - 17 IN.	60.A61V5.004
	LCD BRACKET - 7.5MM L	33.A61V5.005
	LCD BRACKET - 7.5MM R	33.A61V5.006
	LCD CABLE - 7.5MM	50.A61V5.006
	LCD RUBBER	47.A61V5.001

	ASSY LCD MODULE 17.1 WXGA W/GLARE QDI (QDI17TL02-02)	6M.A61V5.013
	LCD 17.1 WXGA W/GLARE QDI (QDI17TL02-02) GARE TYPE	LK.17009.003
	LCD INVERTER - 7.5MM	19.A61V5.001
	LCD PANEL WITH LOGO W/ANTENNA - 7.5MM	60.A61V5.003
	LCD BEZEL - 17 IN.	60.A61V5.004
	LCD BRACKET - 7.5MM L	33.A61V5.005
	LCD BRACKET - 7.5MM R	33.A61V5.006
	LCD CABLE - 7.5MM	50.A61V5.006
	LCD RUBBER	47.A61V5.001

	ASSY LCD MODULE 17.1 WXGA W/GLARE SAM (LTN170WX-L05-E)	6M.A61V5.014
	LCD 17.1 WXGA W/GLARE SAM (LTN170WX-L05-E) GARE TYPE	LK.17006.014
	LCD INVERTER - 7.5MM	19.A61V5.001
	LCD PANEL WITH LOGO W/ANTENNA - 7.5MM	60.A61V5.003
	LCD BEZEL - 17 IN.	60.A61V5.004
	LCD BRACKET - 7.5MM L	33.A61V5.005
	LCD BRACKET - 7.5MM R	33.A61V5.006
	LCD CABLE - 7.5MM	50.A61V5.006





	LCD RUBBER	47.A61V5.001
	ASSY LCD MODULE 17.1 WXGA W/GLARE AU (B170PW02 V.0)	6M.A61V5.015
	LCD 17.1 WXGA W/GLARE AU (B170PW02 V.0) 2 LAMP GARE TYPE	LK.17005.003
	LCD INVERTER - 10MM	19.A61V5.002
	LCD PANEL WITH LOGO W/ANTENNA - 10MM	60.A61V5.005
	LCD BEZEL - 17 IN.	60.A61V5.004
	LCD BRACKET - 10MM L	33.A61V5.007
	LCD BRACKET - 10MM R	33.A61V5.008

	LCD CABLE - 10MM	50.A61V5.007
	LCD RUBBER	47.A61V5.001
	ASSY LCD MODULE 17.1 WSXGA W/GLARE LG (LP171WP5-TL03)	6M.A61V5.016
	LCD 17.1 WXGA W/GLARE LG (LP171WP5-TL03) 2 LAMP GARE TYPE	LK.17108.008
	LCD INVERTER - 10MM	19.A61V5.002
	LCD PANEL WITH LOGO W/ANTENNA - 10MM	60.A61V5.005
	LCD BEZEL - 17 IN.	60.A61V5.004
	LCD BRACKET - 10MM L	33.A61V5.007
	LCD BRACKET - 10MM R	33.A61V5.008

	LCD CABLE - 10MM	50.A61V5.007
	LCD RUBBER	47.A61V5.001
<b>MAINBOARD</b>		
	MAINBOARD 915PM DISCRETE W/TV TUNER ,PCMICA ,CARD READER W/O CPU MEMORY	LB.A6102.001
	MAINBOARD 915PM DISCRETE W/PCMICA ,CARD READER W/O CPU MEMORY TV TUNER	LB.A6202.001
	MAINBOARD 915GM UMA W/PCMICA ,CARD READER W/O CPU MEMORY TV TUNER	LB.A6402.001
	PCMCIA SLOT	22.A61V5.001
	PCMCIA DUMMY CARD	33.A61V5.011
<b>MEMORY</b>		
	MEMORY IFX 256MB/ 533MHZ, HYS64T32000HDL-3.7-A	KN.25602.023
	MEMORY SAMSUNG 512MB/ DDRII 533MHZ, M470T3354BG0-CD5	KN.2560B.011
	MEMORY DDRII 533 256MB HYNIX HYMP532S64P6-C4	KN.2560G.006
	MEMORY DDRII533 256MB NANYA NT256T64UH4A0FN-37B	KN.25603.020
	MEMORY IFX 512MB/ 533MHZ, HYS64T64020HDL-3.7-A	KN.51202.021
	MEMORY DDRII 533 512MB MICRO MT8HTF6464HDY-53EB3	KN.51204.019
	MEMORY DDRII533 512MB SAMSUNG M470T6554BZ0-CD5	KN.5120B.008
	MEMORY DDRII 533 512MB HYNIX HYMP564S64P6-C4	KN.5120G.005
	MEMORY DDRII 533 512MB NANYA NT512T64UH8A0FN-37B	KN.51203.018
	MEMORY DDRII 533 1GB NANYA NT1GT64UH8A0BN-37B	KN.1GB03.006
<b>FAN</b>		
	FAN 5V	23.A61V5.001
<b>HEATSINK</b>		
	THERMAL MODULE - CPU	60.A61V5.006

	THERMAL MODULE - VGA	60.A61V5.007
	NORTH BRIDGE HEATSINK - DISCRETE	23.A61V5.002
	NORTH BRIDGE HEATSINK - UMA	23.A61V5.006
<b>MISCELLANEOUS</b>		
	RUBBER FOOT - BIG	47.A61V5.002
	RUBBER FOOT - SMALL	47.A61V5.003
<b>POINTING DEVICE</b>		
	TOUCHPAD	56.A61V5.001
<b>SPEAKER</b>		
	SPEAKER SET (R&L)	23.A61V5.003
	SUB-WOOFER	23.A61V5.004
*	MIC	23.A61V5.005
		
<b>ACCESSORY</b>		
	REMOTE CONTROLLER - NORMAL -FORWARD 48-KEY	LZ.A2902.001
	REMOTE CONTROLLER - NORMAL -FORMASA 14-KEY	LZ.A6102.001
	REMOTE CONTROLLER - MCE	LC.MCE05.001



	REMOTE CONTROLLER RECEIVER -MCE	LC.MCE05.002
	IR BLASTER - MCE	LC.MCE05.003
<b>CABLE</b>		
	7 PIN MINI-DIN S-VIDEO TO 4 CABLE	50.A61V5.011
	CABLE - 3.5 PHONE JACK TO PAL TV	50.A61V5.013
	NTSC TYPE CONNECTOR TO DVB-T ANT	50.A61V5.014
<b>SCREW</b>		
	SCREW D-SUB NUT	86.A61V5.001
	SCREW M2*3(NL)	86.A61V5.002
	SCREW M2.5*12(NL)	86.A61V5.003
	SCREW M2.5*14	86.A61V5.004
	SCREW M2.5*3(NL)	86.A61V5.005
	SCREW M2.5*4(NL)	86.A61V5.006
	SCREW M2.5*6(NL)	86.A61V5.007
	SCREW M3*4(NL)	86.A61V5.008